



Monticello™

Made in the USA

8' x 16' Greenhouse Assembly Instructions

010713

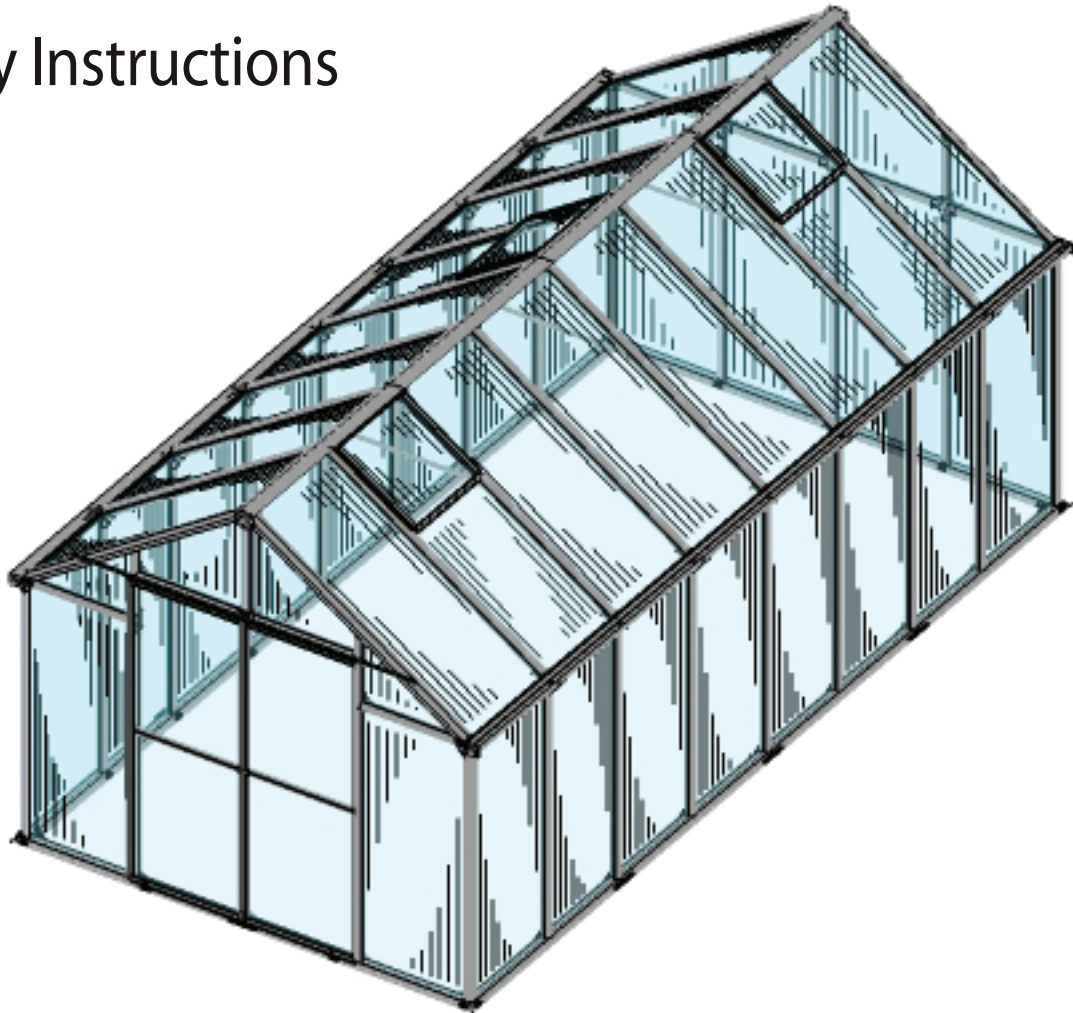

Customer Service: (877) 373-3078 Email: customerservice@rsiww.com



65 Fleetwood Drive, Rockaway, NJ 07866

Introduction

Thank you for purchasing your Monticello™ 8x16 Greenhouse. The Monticello line is proudly made in the USA by a leading commercial greenhouse maker using the same professional grade materials and design. The frame is constructed with the highest quality extruded aluminum with lead free powder-coated paint. The panels are professional grade 8mm twin wall polycarbonate selected for their insulation and durability.

The Monticello line is a modular system, which uses an 8x8 greenhouse that can be easily expanded in four foot sections up to 24 feet by 8 feet at any time. This model consists of an 8x8 greenhouse with two four foot extension kits. It includes three roof vents, each with its own automatic vent opener to ensure proper ventilation and maintain optimal temperature. When properly assembled and maintained, this greenhouse will provide years of enjoyment. It can be expanded as your needs expand.

Our greenhouse has been designed to be easily assembled. Although all but one step can be completed by one person, we recommend using a helper for the entire assembly. You will need assistance from another person to assemble the roof. Allow six to eight hours to complete. If you have never assembled a greenhouse before, make it a weekend project. We recommend you take your time and read these instructions carefully to avoid mistakes.

NOTE: These instructions include helpful hints and important information needed to safely assemble and properly maintain the greenhouse. Please read these instructions completely before you begin.

CAREFULLY READ ALL INSTRUCTIONS BEFORE YOU BEGIN.

FOLLOW STEPS IN THE ORDER PRESENTED. KEEP THIS MANUAL FOR FUTURE REFERENCE.

Before Starting Assembly:

1. Make sure you have all the necessary parts:

Compare the contents of the seven cartons with the List of Parts. If any parts are missing or damaged or if you have any questions, please contact Customer Service by phone at (877) 373-3078 or by email at customerservice@rsiww.com before beginning assembly.

2. Lay the parts out in one staging area:

The List of Parts has the corresponding step number referenced to each part so you can easily prepare for each step. We recommend placing all parts in one staging area. Lay out parts by size and shape. Use the List of Parts to identify the part numbers for profiles and panels. We have not labeled the parts with stickers to avoid removing them during assembly.

3. Select a Location:

When selecting a site for your greenhouse, a flat level surface is essential and if possible, with proper water drainage and easy access to power and water necessary for greenhouse gardening. Choose a sunny, level position away from overhanging trees and power lines and protected from the wind as much as possible. The location should be away from structures that could cause snow to drift on or around the greenhouse. Locate underground pipes or cables before preparing the site or anchoring the greenhouse.

4. Prepare a Foundation:

After choosing a location, proper preparation of the site is essential. The site must be level. The greenhouse must be mounted to a base. Construct the base first so the greenhouse can be securely mounted. We recommend constructing a wood platform base using a perimeter of two by fours filled with either soil, sod or gravel. Instructions for constructing a wood platform can be found on page 3 in this manual.

Other suitable base options include wood decks and concrete slabs. Wood screws are included to secure the greenhouse to a wood base. The greenhouse is secured to the ground from the inside with ground anchors. See step 11 for details. If you are using a concrete base, get appropriate mounting screws before beginning.

Make sure the corners are square by measuring the inside diagonals from both sides and making sure they are equal. Use a spirit level to make sure the base is level.

Contact your local authorities regarding any required building permits or restrictions.

Safety Advice

- The greenhouse must be positioned and fixed on a flat level surface.
- Dispose of all plastic bags safely. Keep them out of the reach of small children.
- Keep children and pets away from the assembly area until the work is completed.
- Always wear work shoes, gloves and safety goggles when working.
- Some of the parts have sharp edges and burs. Use extreme caution when handling.
- Do not lean against or push the greenhouse during assembly.
- Take special care not to touch overhead power lines with the aluminum profiles.
- Do not attempt to assemble the greenhouse in windy or wet conditions.
- Do not position your greenhouse in an area exposed to excessive wind.
- If using power tools or a step ladder, always follow the manufacturer's safety instructions.
- Hot items such as recently used grills, blow torches etc., must not be stored in the greenhouse.
- Store the polycarbonate panels in a cool dark place such as a garage until you are ready to use them.
- Make sure the greenhouse complies with local building codes.

Table of Contents

Introduction	1
Safety Advice	2
General Order of Assembly	2
Construct Wood Platform	3
List of Parts	4
Prepare Set Screws	7
Assemble Base	7
Assemble Right Wall	10
Assemble Back Wall	14
Assemble Left Wall	17
Assemble Front Wall and Gable	21
Assemble Back Gable	27
Assemble Roof Ridge	30
Assemble Roof	32
Install Roof Vents	40
Install Doors	42
Secure to Platform	45

General Order of Assembly

- Step 1: Assemble Base
- Step 2: Assemble Right Wall
- Step 3: Assemble Back Wall
- Step 4: Assemble Left Wall
- Step 5: Assemble Front Wall and Gable
- Step 6: Assemble Back Gable
- Step 7: Assemble Roof Ridge
- Step 8: Assemble Roof
- Step 9: Install Roof Vents
- Step 10: Install Doors
- Step 11: Secure to Platform

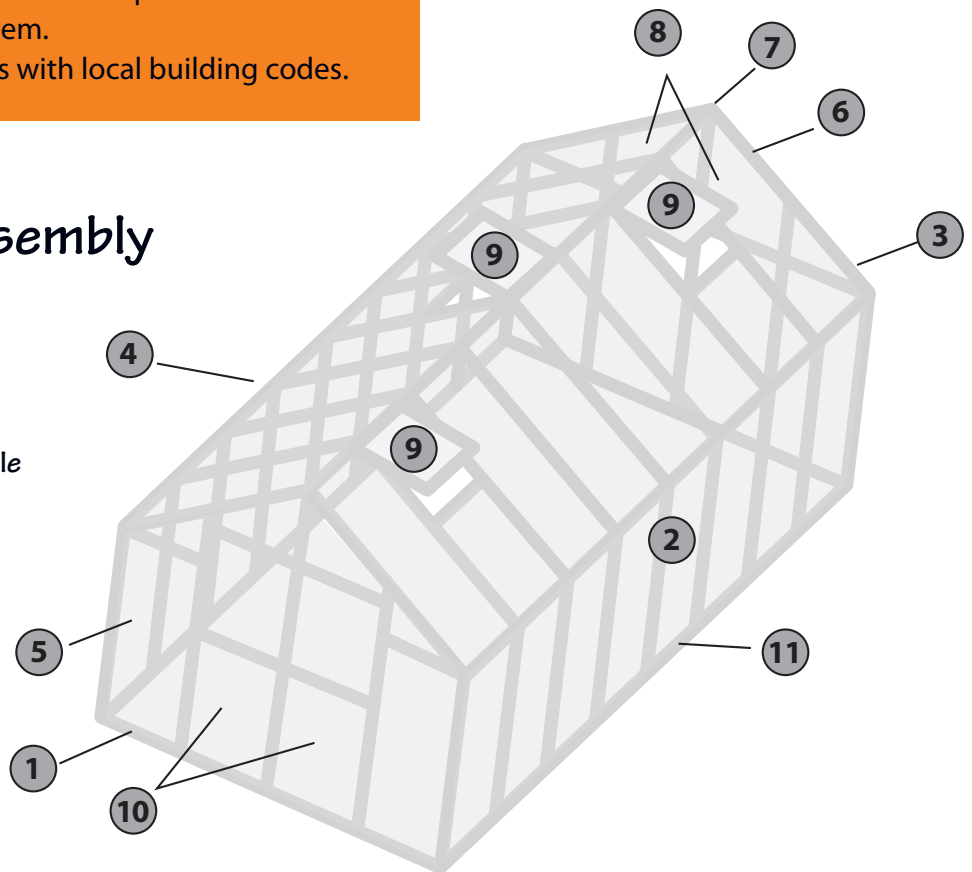

Tools Needed

- Work Gloves
- Safety Goggles
- Step Ladder
- Tape Measure
- Spirit Level
- 7/16" Wrench (included)
- Phillips Screwdriver (included)
- 23 inch spacer (included)
- 5 foot bungee cord (included)

Constructing a Wood Platform



IMPORTANT: It is very important to begin with a level surface. Check your foundation to ensure it is level at every point. If you are not building on a wood deck, we recommend constructing a wood platform so you can properly secure the greenhouse. You must assure your foundation is square and level before beginning assembly.

After choosing a location, proper preparation of the site is essential. The site must be level. Create a wood platform using a perimeter of pressure treated two by fours filled with either soil, sod or gravel.

NOTE: When constructing the greenhouse on a wood deck, make certain the surface is level. Creating an additional wood platform is not necessary.

Buy pressure treated 2x4 lumber. You will use two layers with the corner positions staggered for maximum strength. The finished dimensions will be 101" by 198¼"

Materials:

Four 10' pressure treated 2x4 lumber cut to 97½"
Four 10' pressure treated 2x4 lumber uncut at 120"
Four 8' pressure treated 2x4 lumber cut to 74¾"
Eighty #8 3" wood screws

Tools:

Spirit Level
Corner Square
Phillips Screwdriver
Power Drill (recommended)

Make sure each corner is square and then secure one corner with wood screws. Move to the diagonal corner, make sure it is square and then secure with wood screws. As you continue to secure the 2x4 wood platform, continue to make certain the corners are square and the frame is level.

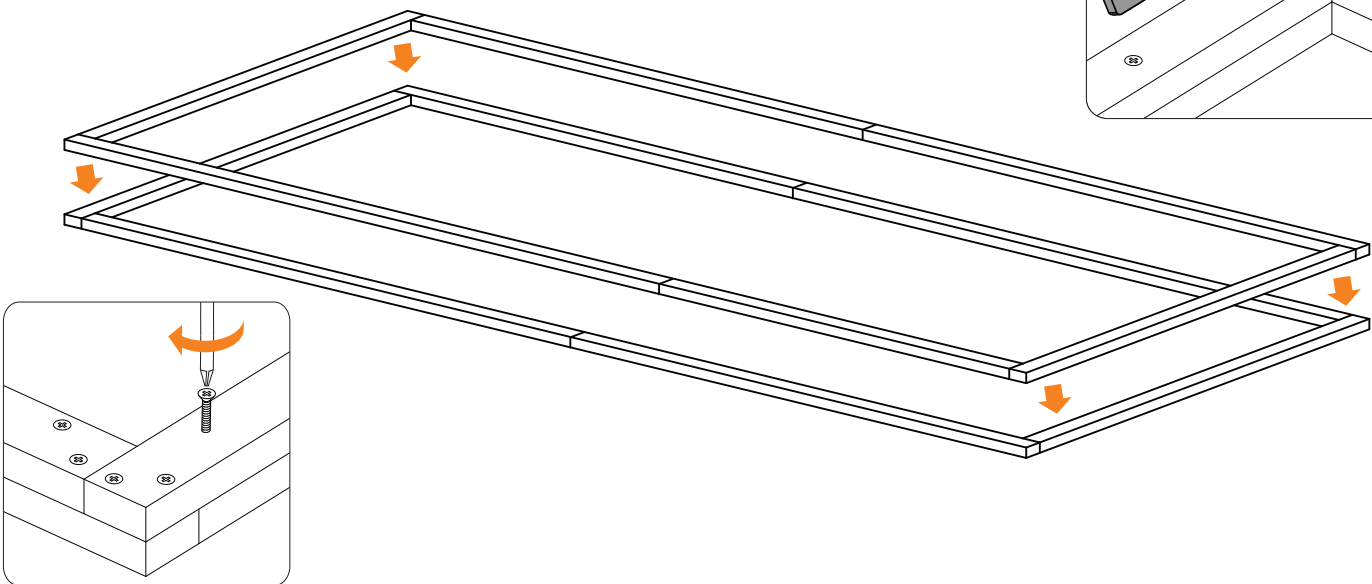
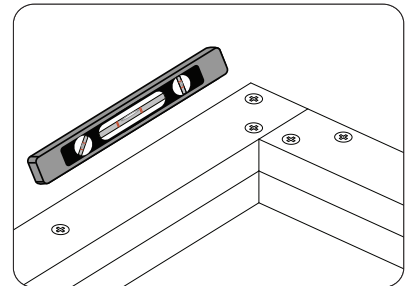

Secure wood platform every two feet with wood screws. Make certain to tighten screws into the wood platform until they are flush with the surface.

NOTE: The illustrations throughout the manual are shown without a foundation.

List of Parts



WARNING: Profiles with cut edges and/or drilled holes are sharp. Use extreme caution when handling.



The greenhouse is shipped in six cartons. These cartons are heavy. Use care when lifting them.
 Some parts have sharp edges. Use extreme caution when handling.
 Wear proper safety gear including work shoes, gloves and safety goggles.
 Keep children and pets away until assembly is complete.
 Finish assembling the roof in one session. Do not leave the roof unattended until it is completely assembled.
 Place all like parts together in a staging area. Prepare for each step according to instructions in this manual.

If any parts are missing or damaged, contact Riverstone Customer Service before beginning assembly:
 Customer Service: (877) 373-3078 or email: customerservice@rsiww.com











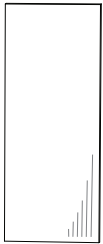

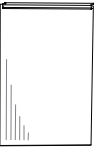
Profile	QTY		
	F-1	33	Steps 2,3,4, 5,8
	F-2	1	Step 6
	F-3	4	Steps 5,6
	F-4	1	Step 5
	F-5	1	Step 5
	F-6	4	Steps 5,6
	F-7	8	Steps 2,3,4, 5,6

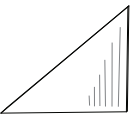
Profile	QTY		
	F-10	2	Step 3
	G-1	4	Steps 2,4
	G-2	6	Steps 2,4
	P-1A	4	Step 1
	P-1B	4	Step 1
	P-2A	2	Step 1
	P-2B	2	Step 1
	R-1	2	Step 7
	R-1E	2	Step 7

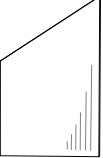
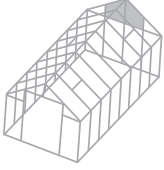
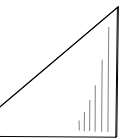
List of Parts (continued)



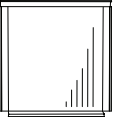



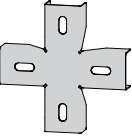
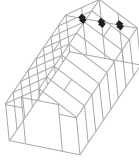
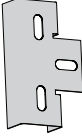
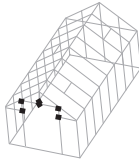
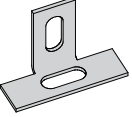
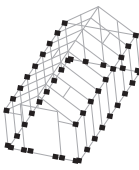
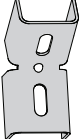
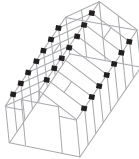
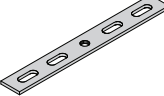
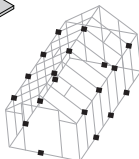
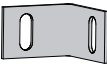
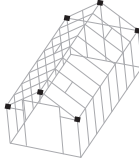
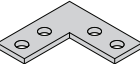
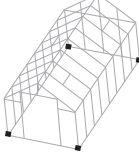
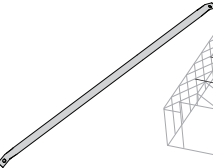
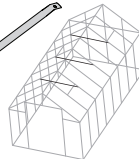



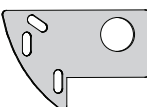
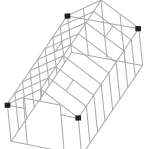
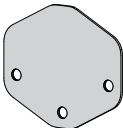
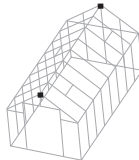

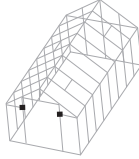
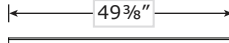
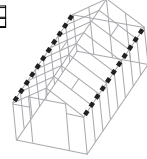
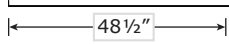
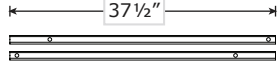
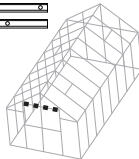

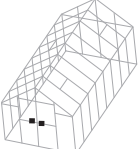
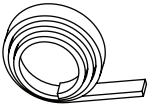
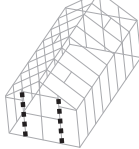
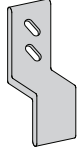
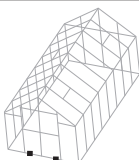
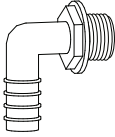
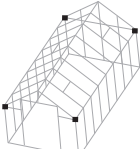



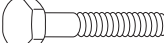

WARNING: Use extreme caution when handling panels with cut edges. The corners are sharp.

Panels		QTY		
		W-1	35	Steps 2,3,4,8
24" x 57"				
		W-2	3	Step 8
24" x 32 1/4"				
		W-3	4	Steps 4,5
24" x 15 1/2"				
		W-4	2	Step 5
24" x 31 1/4"				
		W-5	2	Step 4
24" x 21 3/4"				
Assembled Doors and Vents		QTY		
		D-2L	1	Step 10
24" x 65"		D-2R	1	Step 10
		V-2	3	Step 9
24" x 24 3/4"				

Connectors		QTY		
		B-1	6	Steps 4,6
		B-2	6	Step 5
		B-3	47	Steps 2,3,4,5,10
		B-4	21	Step 8
		B-5	19	Steps 1,2,4,7
		B-7	6	Steps 5,6,7
		B-8	4	Step 1
Brace		QTY		
		B-9	3	Step 8

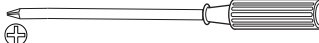
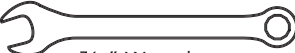
List of Parts (continued)

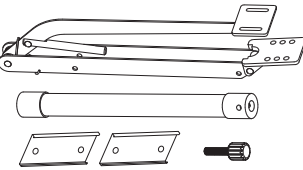
Connectors		QTY		
		C-1	4	Steps 5,6
		C-2	2	Step 7
Trim Plates		QTY		
		B-6	2	Step 5
		G-4	4	Step 8
		G-4E	4	Step 8
Door Parts		QTY		
		D-1L	1	Step 10
		D-1R	1	Step 10
		D-3	2	Step 10
		D-4	12'	Step 10
		D-5	2	Step 10
Gutter Drain		QTY		
		G-3	4	Step 8

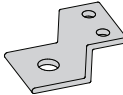
Hardware		QTY		
	S-1	12	Step 9	
	S-2A	349	Steps 1,2,3,4,5,6,7,8,10,11	
	S-2B	349		
	S-2C	349		
	S-3	4	Step 10	
	S-4	80	Steps 1,11	
	S-5A	3	Step 7	
	S-5B	3	Step 8	
	S-2C	3	Step 8	
	S-6	6	Step 9	
Included Tools		QTY		
	T-1	1	Steps 8,9,10,11	
	T-2	1	Steps 1,2,3,4,5,6,7,8,10	
	T-3	1	Steps 2,3,4	
	T-4	3	Step 8	
Vent Opener		QTY		
	V-3	3	Step 9	
Ground Anchors		QTY		
	A-1	8	Step 11	
	A-2	8	Step 11	

Assemble Base



Make certain the pieces are in the correct positions before assembling. Carefully follow the order of assembly to ensure an easy installation. Wear proper safety gear including work shoes, gloves and goggles.

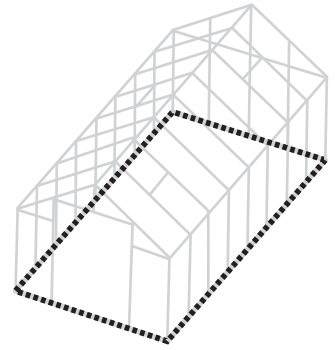

1.1A We use a set screw and nut assembly system for ease of installation. With the hex shaped indent facing up, screw S-2B threaded part into S-2A nut until it is flush with bottom of nut. When the assembly is flush it will slide easily in the bolt tracks.

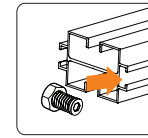
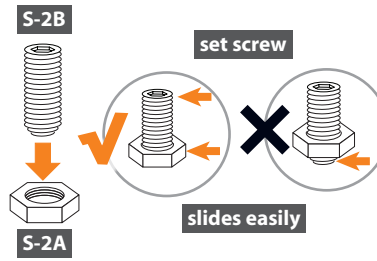

NOTE: The two pieces together is referred to in this manual as a "set screw".

Shown sliding into F-1 bolt track.



IMPORTANT: One end of the S-2B threaded set screw has a hex shaped indent. The other end forms a soft point. Make sure indented hex is always facing up when screwed into the S-2A nut. This way if the set screw is installed too tightly to loosen by hand, you can use a hex key.

1.1B After sliding into bolt track, screw threaded part farther into nut so end touches the edge of the profile and holds in place. Do not over tighten. It will be difficult to loosen again to adjust position to fit holes in connectors.

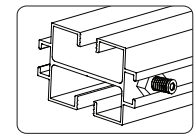

Shown hand tightened in F-1 bolt track.

NOTE: Screwing S-2B threaded part farther into nut so it holds is referred to in this manual as "hand tighten". "Loosen set screw" refers to unscrewing the S-2B threaded part enough so set screw easily slides.



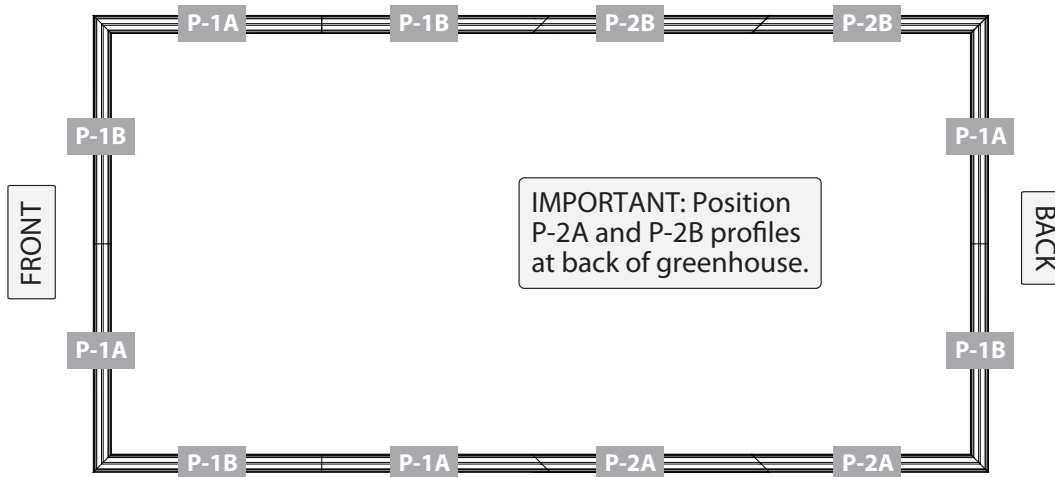

NOTE: We recommend assembling all set screws before beginning. Each step shows quantity needed separately. Connectors are secured with S-2C bolt using set screws in later steps.

1.2 The base is made up of four P-1A, four P-1B, two P-2A and two P-2B profiles. Arrange profiles in a rectangle as shown. Position P-2A and P-2B profiles at back sides of the greenhouse.

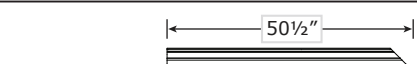

WARNING: Use extreme caution when handling profiles P-1A, P-1B, P-2A and P-2B. The bottoms may have sharp edges near the drilled holes. The cut edges on the corners of these profiles are sharp.

IMPORTANT: Make sure the base fits properly on your foundation. If not, stop and fix your foundation.

Profile	QTY
 50 1/2"	P-1A 4
	P-1B 4
 52 1/8"	P-2A 2
	P-2B 2

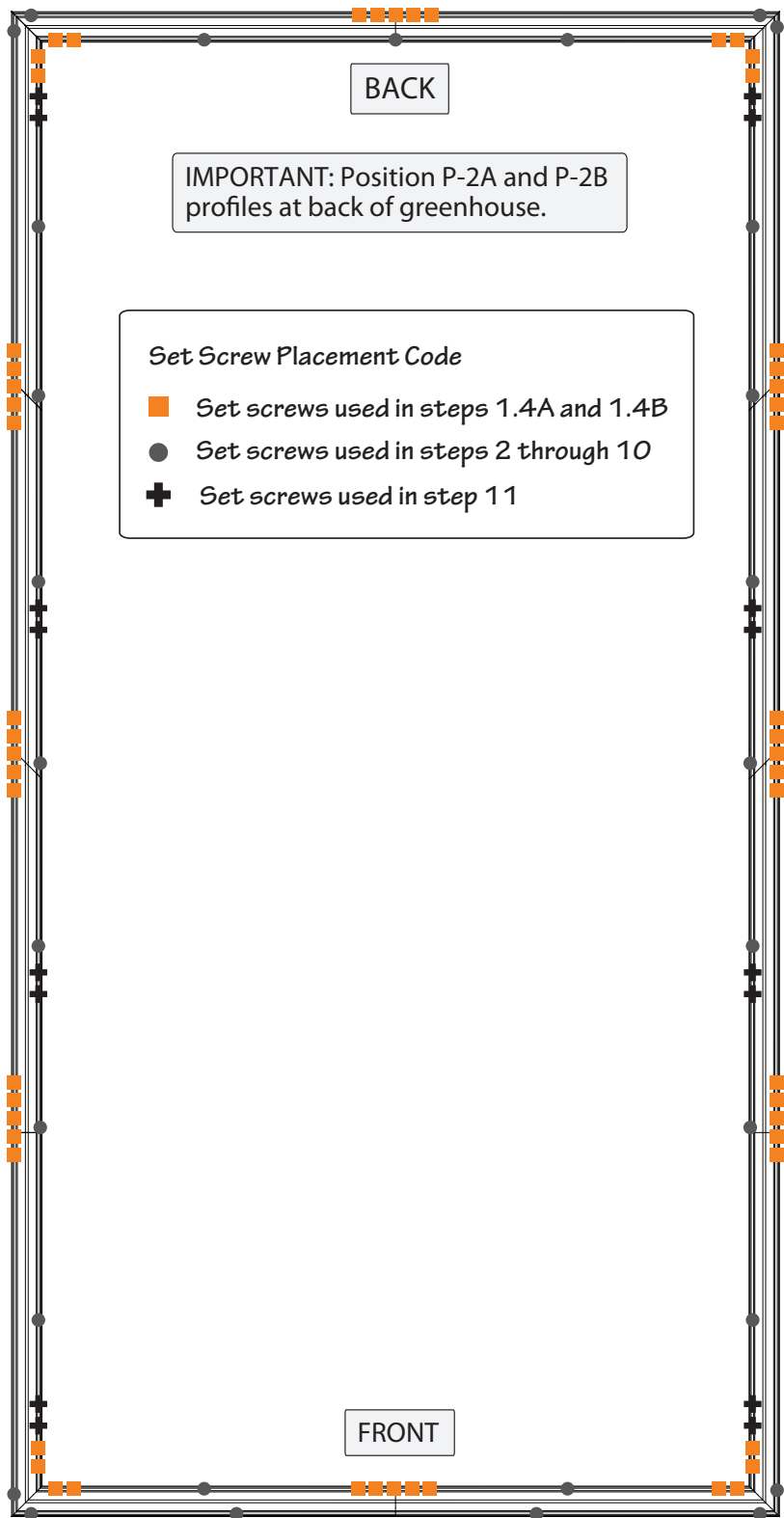

1.3 Separate profiles to install set screws into inside and outside bolt tracks. Some of the set screws will be secured in this step. Most are used in later steps. They are difficult to install after the base is assembled. Pay careful attention to ensure you have the correct number of set screws in the correct bolt track in each profile. The profiles have different amounts of screws on the inside and outside bolt tracks. The chart and illustration show the set screw placement.

IMPORTANT: When assembling base, make sure the profiles are straight and flush against each other. Secure profiles together, and ensure corners are square. The diagonal measurements on inside corners should be equal. Secure corners to desired foundation until assembly is completed. We recommend using a two by four platform.



NOTE: Instructions identify sixteen set screws necessary for securing to ground in step 11.

- Set Screw Placement Code*
- Set screws used in steps 1.4A and 1.4B
 - Set screws used in steps 2 through 10
 - ✚ Set screws used in step 11

Connector		QTY
	S-2A	101
	S-2B	101

1.4A Make certain side profiles are straight and flush. Adjust position of set screws in inner bolt track at front of profile to fit holes in B-5 connector. Center connector over seam for maximum hold. Secure using five bolts. Repeat on outer bolt track to install seven remaining B-5 connectors at back and sides.

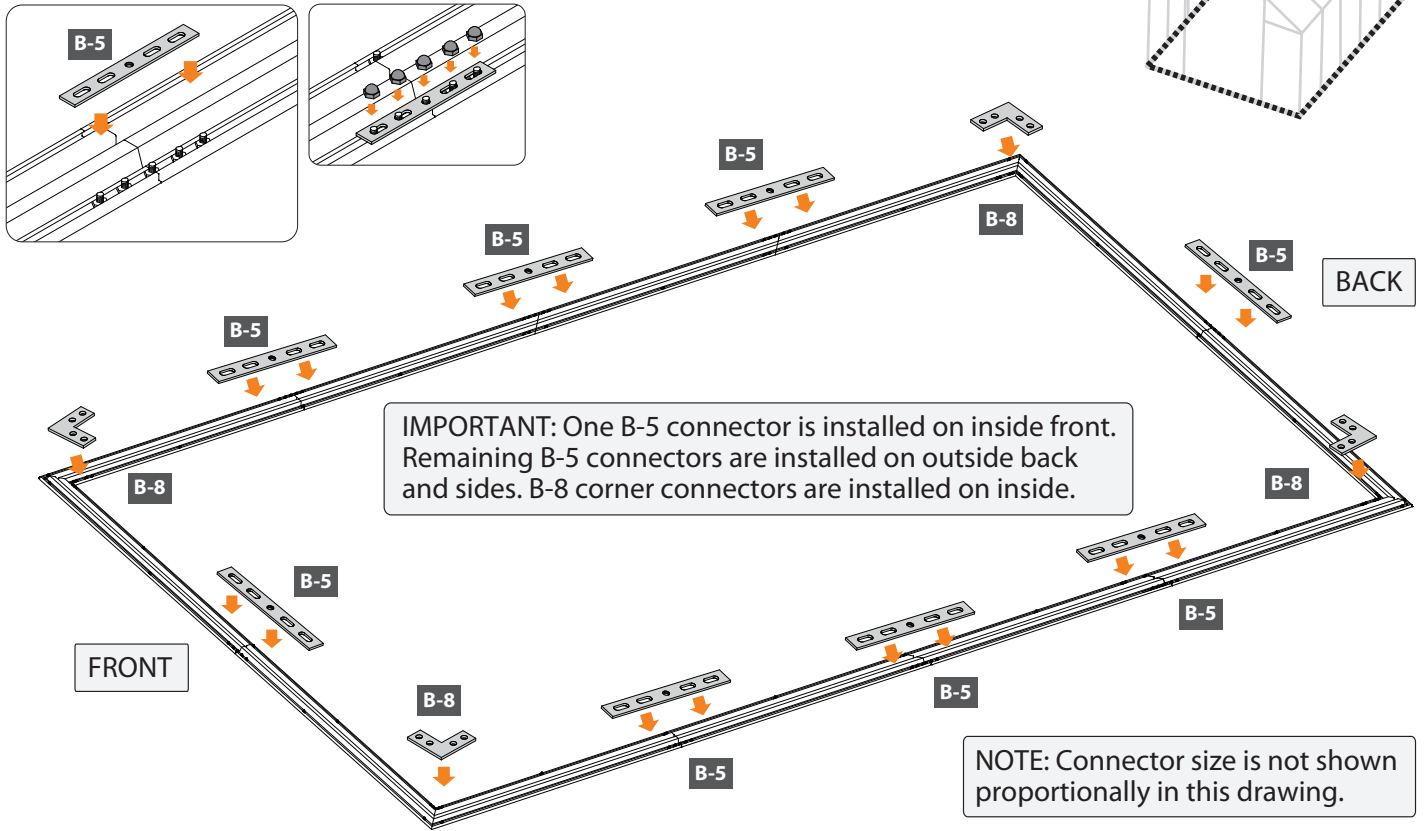
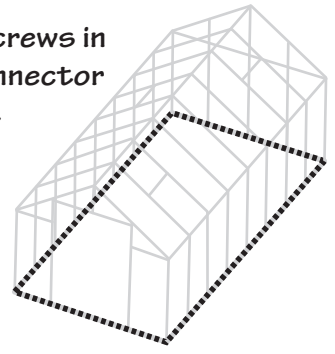

1.4B Make certain corners line up and are flush. Adjust position of set screws in inner bolt track to fit holes in B-8 connector. Secure with four bolts. Repeat until each corner is secure.

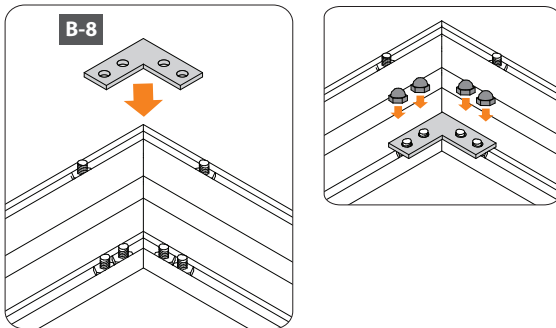

IMPORTANT: Double check the position and amount of unused set screws in the base. You should have 45 available for later assembly.

Connector	QTY	Connector	QTY
B-5	8	B-8	4
S-2C	40	S-2C	16

1.5A Measure base diagonally from inside corner. Equal measurements ensure the base is square. Use a spirit level to make sure the base is level.

1.5B Locate predrilled holes in base profiles and use six S-4 screws, one at each corner and one in the center of each side to secure to wood platform. You will secure the greenhouse completely to the platform in step 11.1 when assembly is finished.

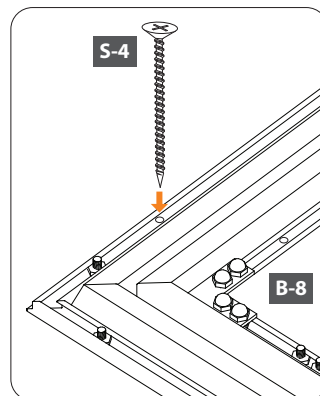

Connector	QTY
S-4	6

Assemble Right Wall

NOTE: Have the hex shaped indent facing up. Screw in until it is flush with bottom of nut so it slides easily into bolt tracks. After inserting into bolt track, screw in until it holds in place.

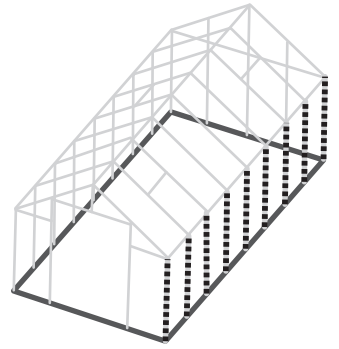

Make certain the pieces are in the correct positions before assembling. Carefully follow the order of assembly to ensure an easy installation. Wear proper safety gear including work shoes, gloves and goggles. Prepare needed set screws as shown in step 1.1A

2.1A Prepare two F-7 corner profiles. Slide set screws into all three bolt tracks on one end and into two side bolt tracks on other end of corner profiles. Hand tighten each set screw to hold in place.

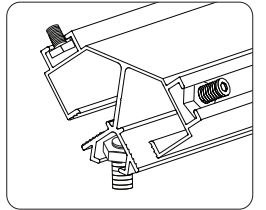
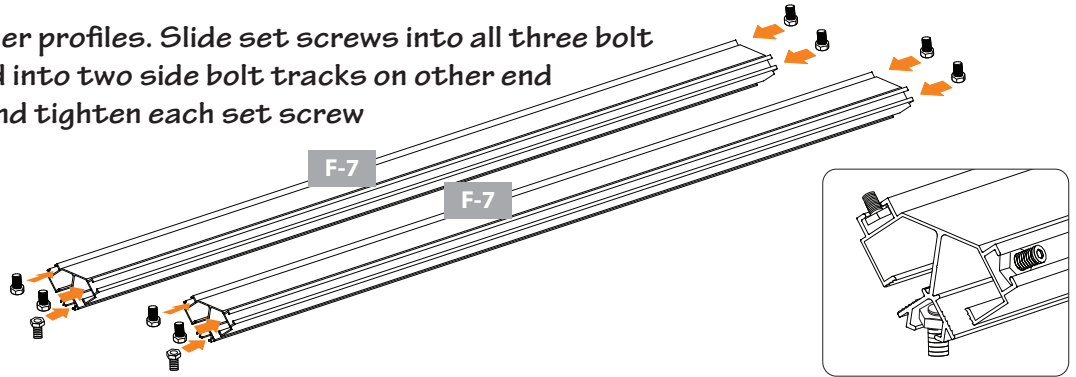
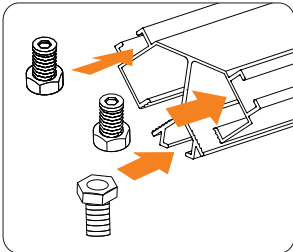



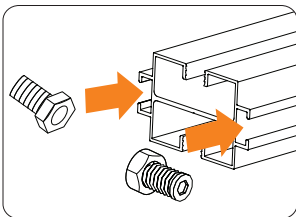
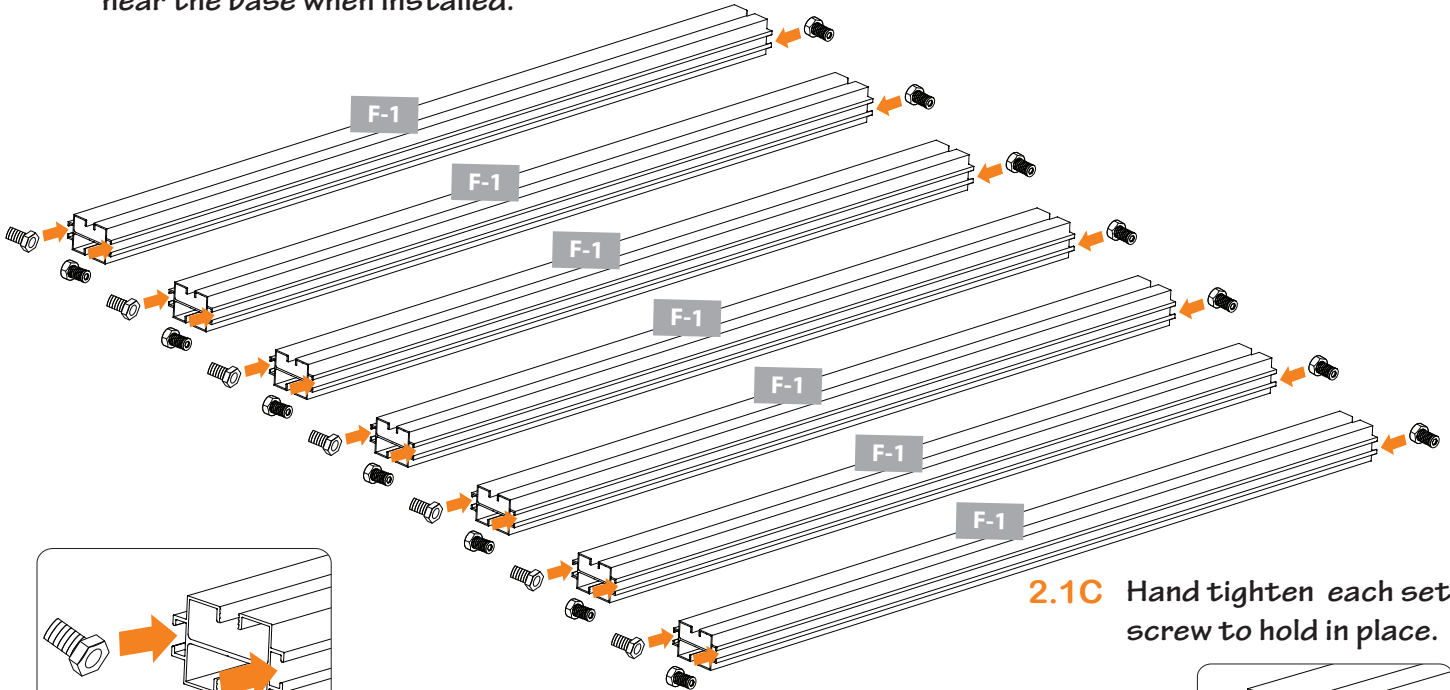

NOTE: Set screw in center bolt channel is used when installing optional shelving units. Install F-7 profile with set screw near base until needed.

2.1B Prepare seven F-1 wall profiles. Slide set screws into both bolt tracks on one end of profile and one bolt track on the other end. The single set screw will sit on the inside of the greenhouse near the base when installed.

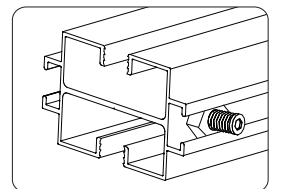

2.1C Hand tighten each set screw to hold in place.



Profile	QTY	Connector		QTY
 <div style="display: flex; align-items: center; margin-left: 10px;"> <div style="width: 100px; border-bottom: 1px solid black; margin-right: 5px;"></div> <div style="text-align: center; width: 20px;">56"</div> <div style="width: 100px; border-bottom: 1px solid black; margin-left: 5px;"></div> </div>	F-7	2		31
 <div style="display: flex; align-items: center; margin-left: 10px;"> <div style="width: 100px; border-bottom: 1px solid black; margin-right: 5px;"></div> <div style="text-align: center; width: 20px;">56"</div> <div style="width: 100px; border-bottom: 1px solid black; margin-left: 5px;"></div> </div>	F-1	7		31

2.2A Begin at front right corner. Remove plastic film from both sides of one W-1 panel. Fit panel into channel in base, placing side marked "UV Resistant" facing outside. The panels will help hold the profiles up during assembly.

2.2B Place F-7 corner profile on base, fitting panel into channel. Slide set screws into base so they line up. Fit B-3 connector on each side.

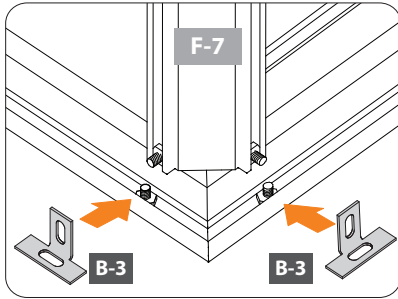
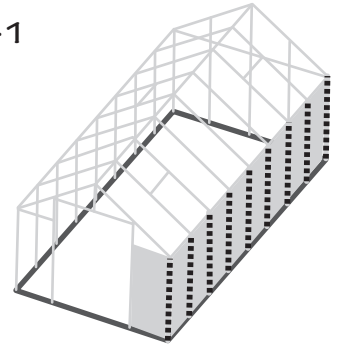

2.2C Secure with four S-2C bolts.

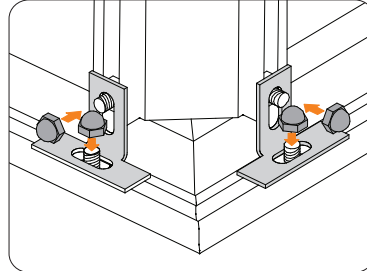

NOTE: VIEWS ARE FROM OUTSIDE.

2.3A Continue working from inside. Remove plastic film from both sides of one W-1 panel. Fit panel into channel in base and corner profile, placing side marked "UV Resistant" facing outside.

IMPORTANT: The panels expand and contract depending on the temperature. To ensure proper placement, use the 23 inch spacer included with the tools.

2.3B Place 23 inch spacer on base next to F-7 corner profile. Fit panel into channel in F-1 profile and slide F-1 profile against spacer to ensure proper placement. Position F-1 profiles so single set screw is next to base on inside.

NOTE: Panels will not fit completely to end of channels. There will be some space to allow for temperature changes.

2.3C Fit B-3 connector and secure with two S-2C bolts.

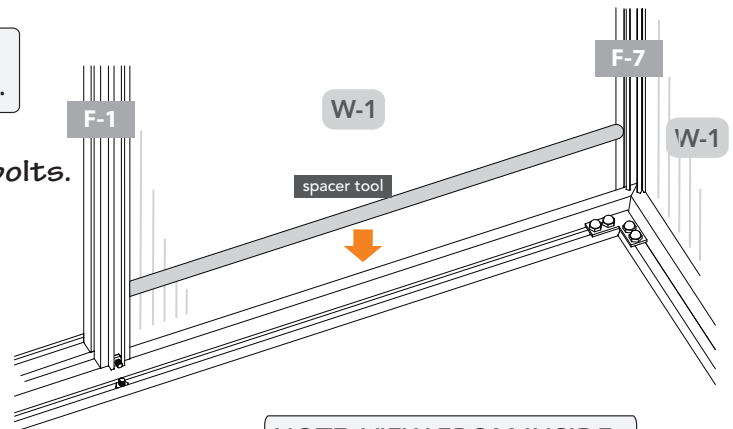
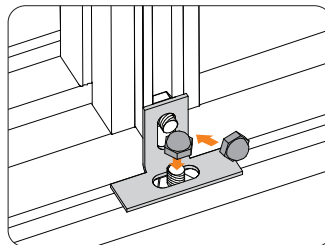
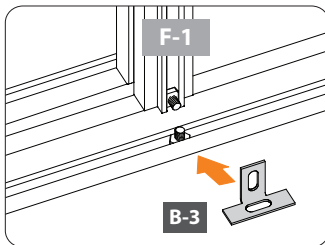



NOTE: VIEW FROM INSIDE.

2.3D Continue building the side wall from the inside. Use the spacer with each panel and the six remaining F-1 profiles. Repeat steps 2.3A through 2.3C.

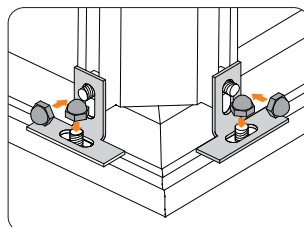
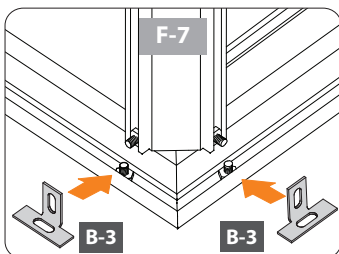
2.4 Add the last W-1 panel to complete the side. From the outside, fit F-7 corner profile into place and secure.



NOTE: VIEW FROM OUTSIDE.

Panel	QTY	Connector	QTY
 24" x 57"	9		11
W-1	9		22

2.5A Prepare two G-1 gutter profiles by sliding four set screws into bottom bolt track. Hand tighten each end set screw to hold in place.

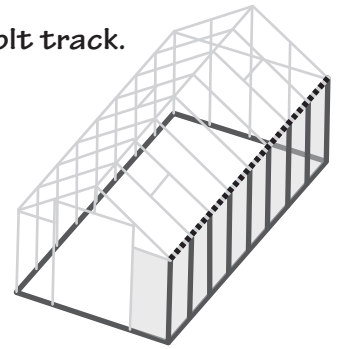
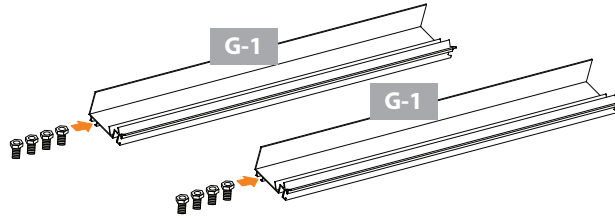
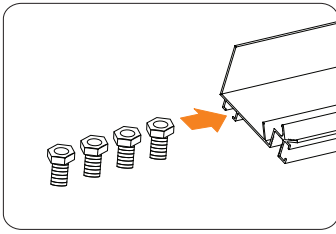

2.5B Prepare two G-2 gutter profile with six set screws and one G-2 gutter profile with five set screws. Slide set screws into bottom bolt track. Hand tighten end set screw to hold in place.

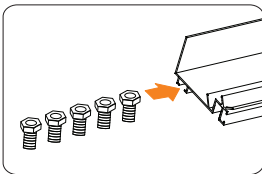
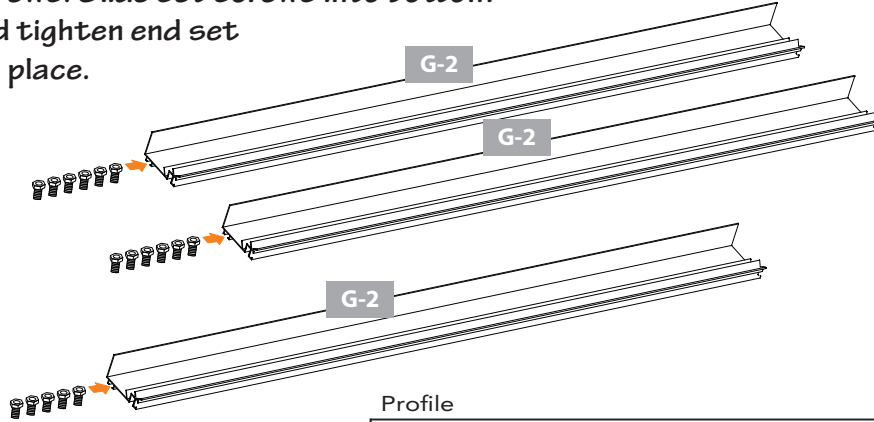
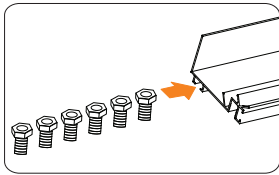

Connector		QTY	Profile		QTY
	S-2A	25		G-1	2
	S-2B	25		G-2	3

2.6A Working from inside, place G-1 and G-2 gutter profiles, fitting top edge of W-1 panels into channels of gutters. Place one short G-1 gutter profile at each end and the three longer G-2 gutter profiles in the center. Seams are centered to bolt tracks in F-1 profiles.

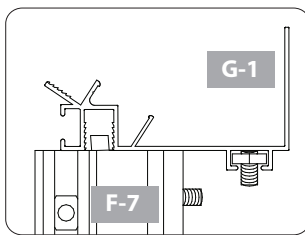

NOTE: At front and back, edge of G-1 gutter profile lines up flush with edge of F-7 corner profile.

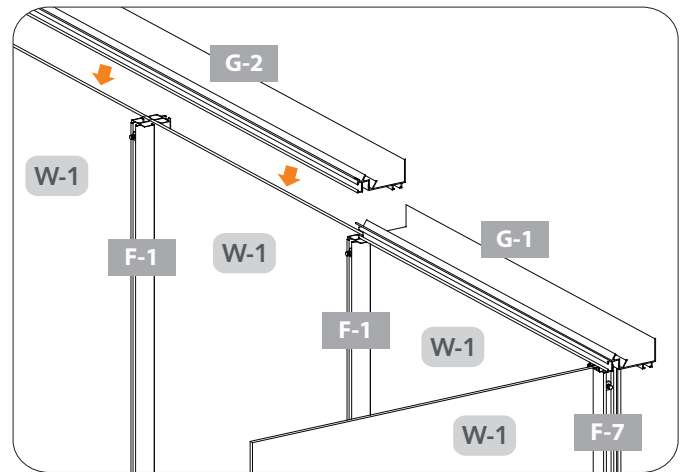

NOTE: VIEW FROM INSIDE.

2.6B Place one set screw on the inside bolt track of the gutter at each end. Hand tighten both set screws to hold in place.

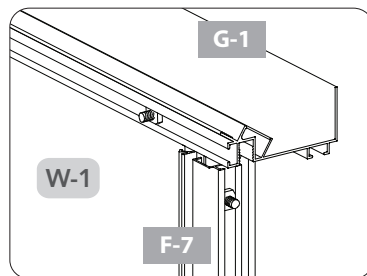
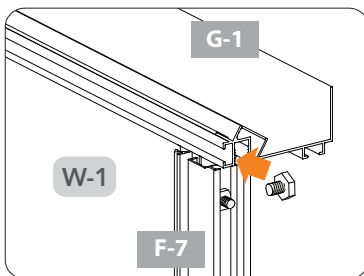

NOTE: VIEWS FROM INSIDE.

Connector		QTY
	S-2A	2
	S-2B	2

2.7A The gutters are secured together using B-5 connectors and attached to side profiles using B-3 connectors on the outside of the greenhouse. The B-3 connector uses the set screw in the center hole of B-5 connectors at seams. Loosen and slide set screws to line up with connectors making sure the seams line up and the gutters remain straight.

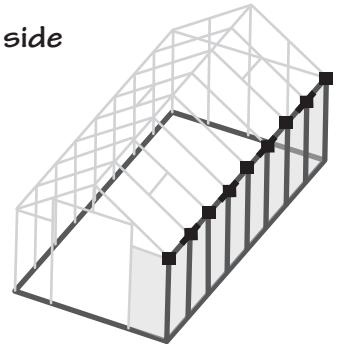

2.7B Begin at the four seams and arrange set screws so middle screw is centered. Fit B-5 connector onto gutter and hold in place using the two end bolts.

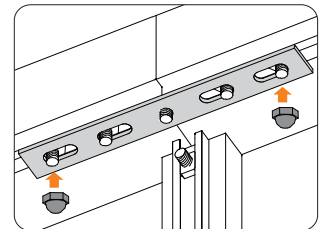
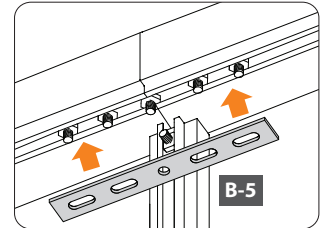
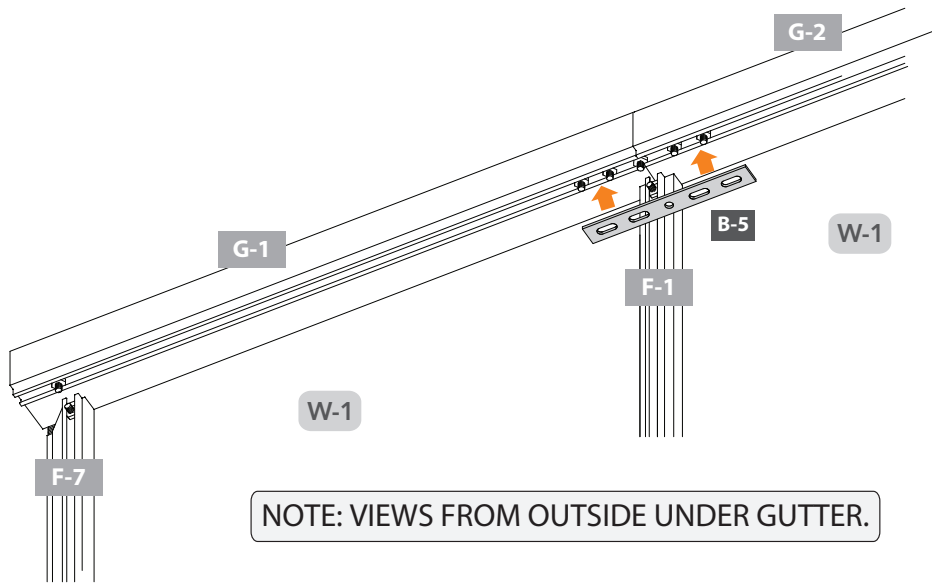

2.7C Loosen set screws on side profiles and slide down. Fit wide part of B-3 connector onto set screw, slide up into place fitting gutter set screw at other end. Tighten set screws and secure with bolts.

NOTE: The bottom of B-3 connector extends past the edges of side and corner profiles. B-3 connector sits over B-5 connector. Secure all with bolts.

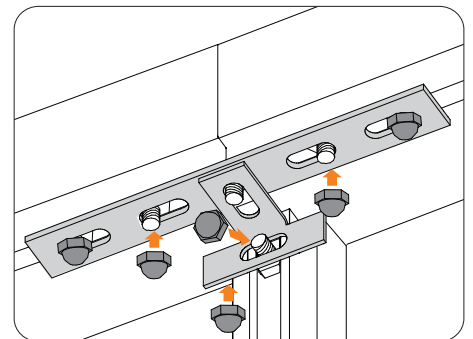
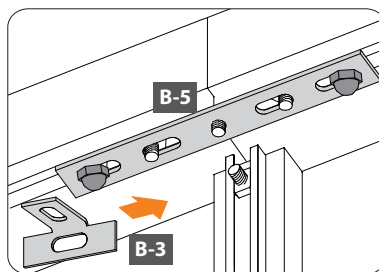
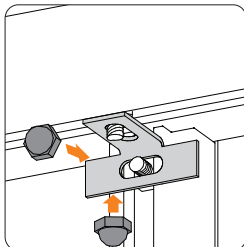
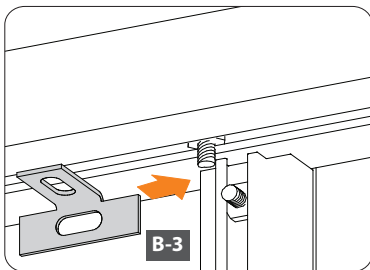

NOTE: VIEWS FROM OUTSIDE UNDER GUTTER.

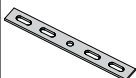
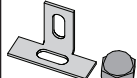
Connector		QTY	Connector		QTY
	B-5	4		B-3 S-2C	9 34

2.5A Prepare two G-1 gutter profiles by sliding four set screws into bottom bolt track. Hand tighten each end set screw to hold in place.

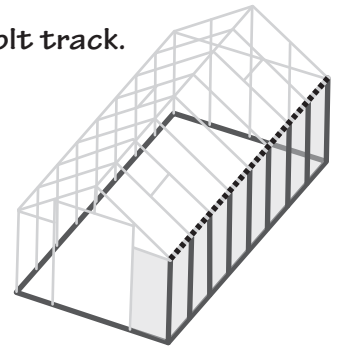
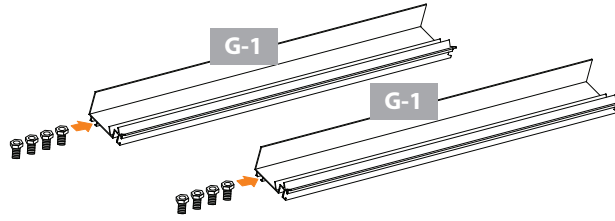
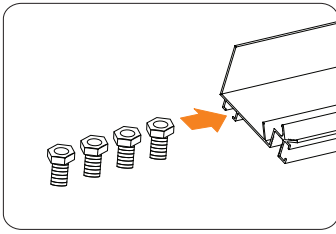

2.5B Prepare two G-2 gutter profile with six set screws and one G-2 gutter profile with five set screws. Slide set screws into bottom bolt track. Hand tighten end set screw to hold in place.

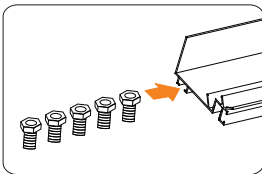
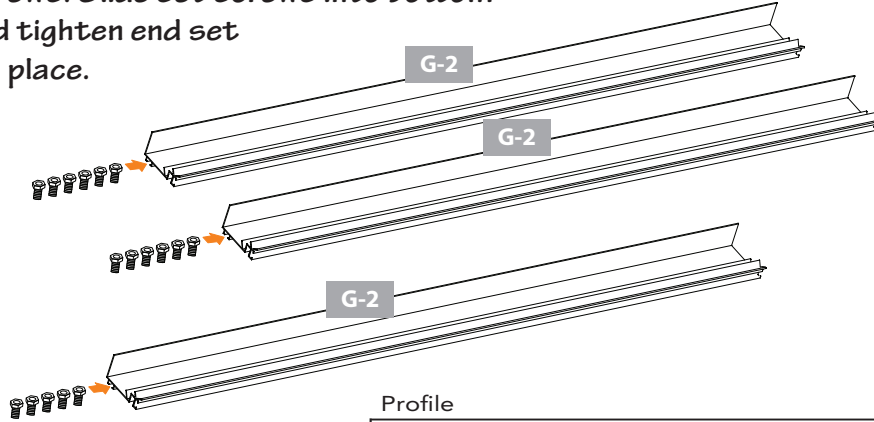
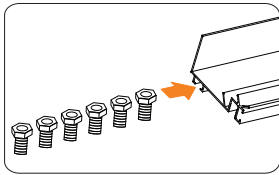

Connector		QTY	Profile	Profile	QTY
	S-2A	25			
	S-2B	25		G-2	3

2.6A Working from inside, place G-1 and G-2 gutter profiles, fitting top edge of W-1 panels into channels of gutters. Place one short G-1 gutter profile at each end and the three longer G-2 gutter profiles in the center. Seams are centered to bolt tracks in F-1 profiles.

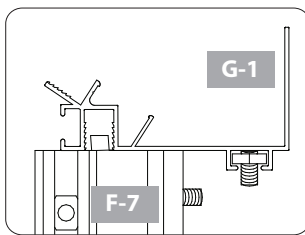

NOTE: At front and back, edge of G-1 gutter profile lines up flush with edge of F-7 corner profile.

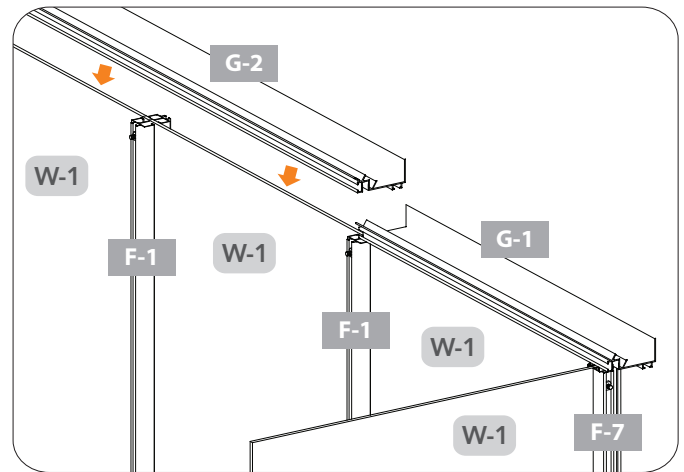

NOTE: VIEW FROM INSIDE.

2.6B Place one set screw on the inside bolt track of the gutter at each end. Hand tighten both set screws to hold in place.

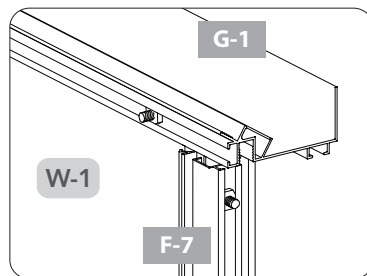
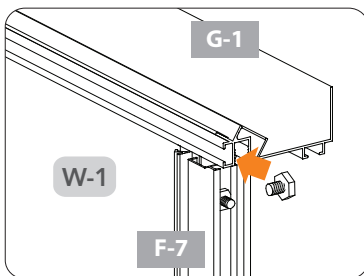

NOTE: VIEWS FROM INSIDE.

Connector		QTY
	S-2A	2
	S-2B	2

2.7A The gutters are secured together using B-5 connectors and attached to side profiles using B-3 connectors on the outside of the greenhouse. The B-3 connector uses the set screw in the center hole of B-5 connectors at seams. Loosen and slide set screws to line up with connectors making sure the seams line up and the gutters remain straight.

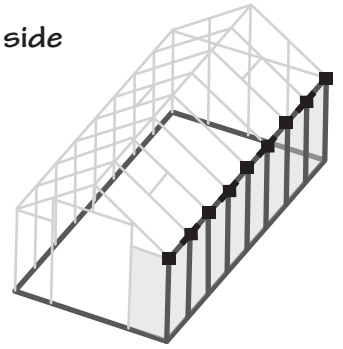

2.7B Begin at the four seams and arrange set screws so middle screw is centered. Fit B-5 connector onto gutter and hold in place using the two end bolts.

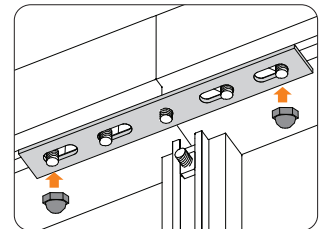
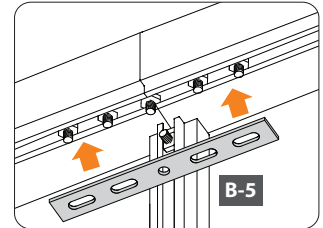
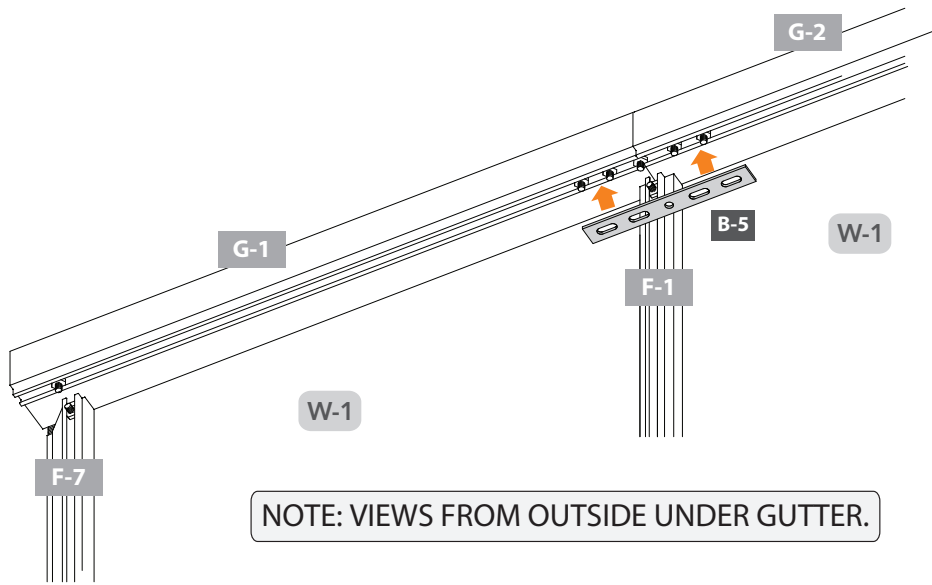

2.7C Loosen set screws on side profiles and slide down. Fit wide part of B-3 connector onto set screw, slide up into place fitting gutter set screw at other end. Tighten set screws and secure with bolts.

NOTE: The bottom of B-3 connector extends past the edges of side and corner profiles. B-3 connector sits on top of B-5 connector. Secure all with bolts.

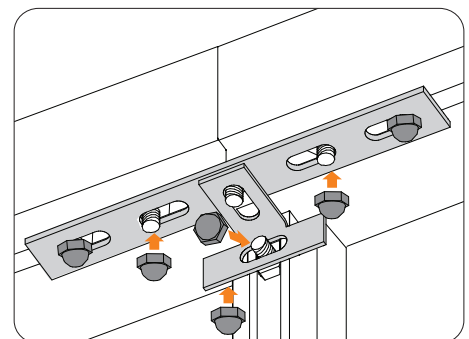
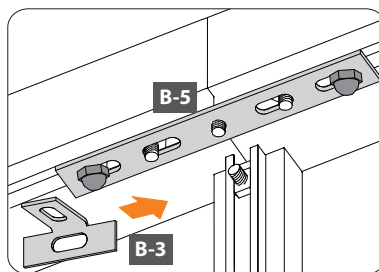
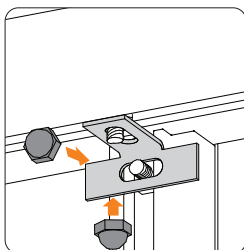
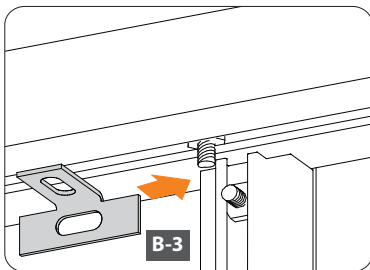

NOTE: VIEWS FROM OUTSIDE UNDER GUTTER.

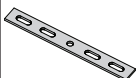
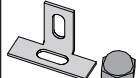
Connector		QTY	Connector		QTY
	B-5	4		B-3 S-2C	9 34

Assemble Back Wall

NOTE: Have the hex shaped indent facing up. Screw in until it is flush with bottom of nut so it slides easily into bolt tracks. After inserting into bolt track, screw in until it holds in place.

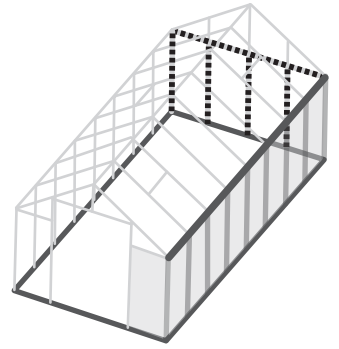

Make certain the pieces are in the correct positions before assembling. Carefully follow the order of assembly to ensure an easy installation. Wear proper safety gear including work shoes, gloves and goggles. Prepare needed set screws as shown in step 1.1A

3.1A Prepare one F-7 corner profile. Slide set screws into all three bolt tracks on one end and into two side bolt tracks on other end of corner profile. Hand tighten each set screw to hold in place.

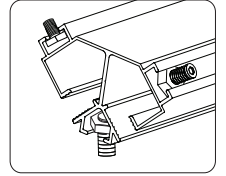
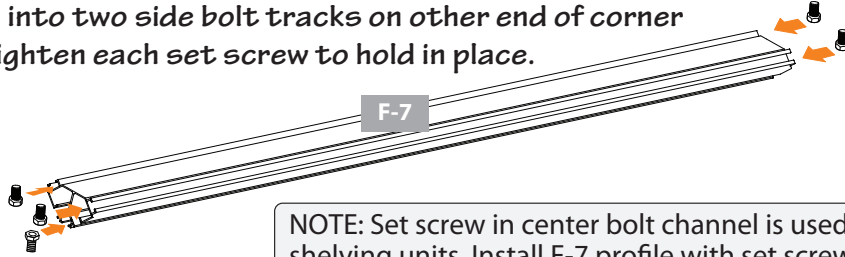
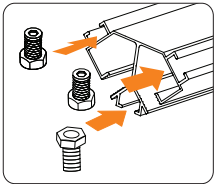

NOTE: Set screw in center bolt channel is used when installing optional shelving units. Install F-7 profile with set screw near base until needed.

3.1B Prepare three F-1 wall profiles. Slide set screws into both bolt tracks on one end of profile and one bolt track on the other end. The single set screw will sit on the inside near the base when installed. Hand tighten each set screw to hold in place.

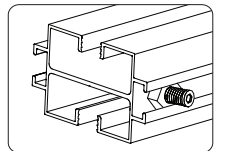
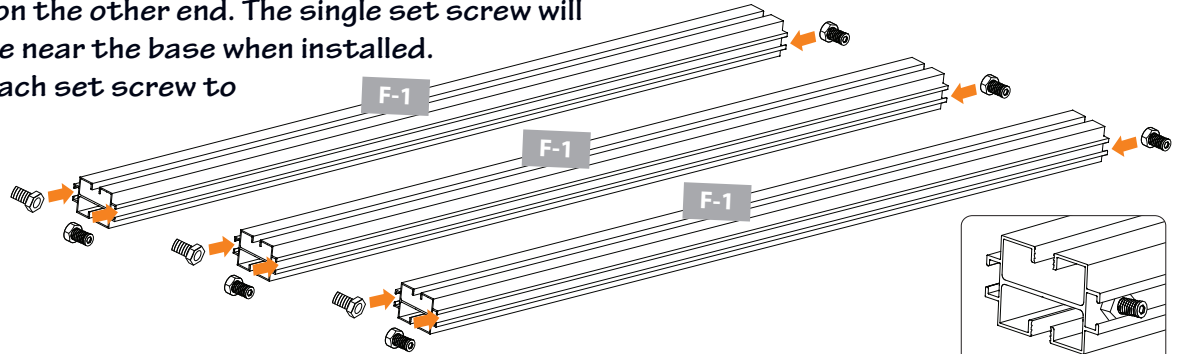
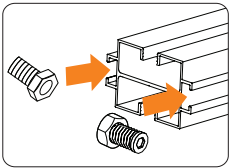

3.1C Prepare two F-6 profiles. Slide set screws into both bolt tracks on each end of two F-6 mitered profiles. Hand tighten each set screw to hold in place.

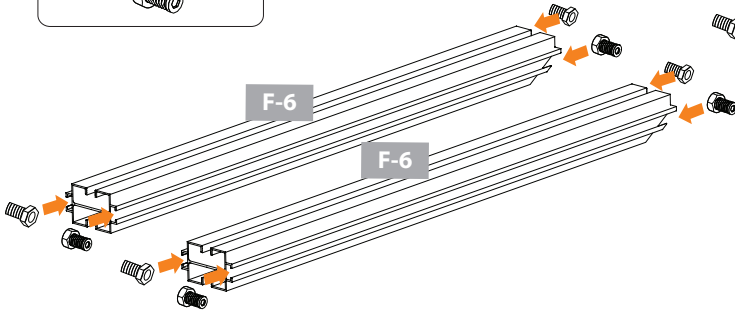
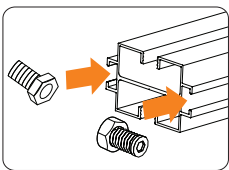

3.1D Prepare two F-10 profiles. Slide set screws into both bolt tracks on each end of two F-10 profiles. Hand tighten each set screw to hold in place.

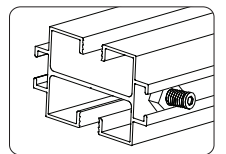
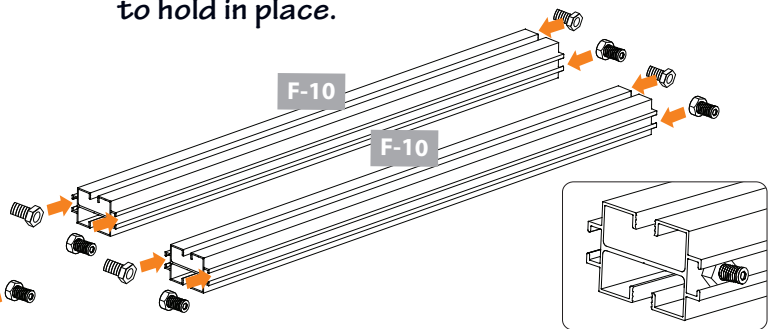

Connector		QTY
	S-2A	30
	S-2B	30

Profile		QTY	Profile		QTY	
	23"	F-6	2		F-7	1
	23"	F-10	2		F-1	3

3.2A Working from inside, remove plastic film from both sides of one W-1 panel. Fit panel into channel in base and corner profile, placing side marked “UV Resistant” facing outside.

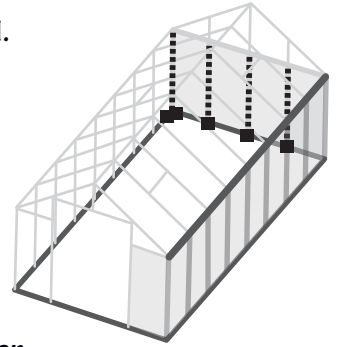

IMPORTANT: The panels expand and contract depending on the temperature. To ensure proper placement, use the 23 inch spacer included with the tools.

3.2B Place 23 inch spacer on base next to F-7 corner profile. Fit panel into channel in F-1 profile and slide F-1 profile against spacer to ensure proper placement. Position F-1 profiles so single set screw is next to base on inside.

NOTE: Panels will not fit completely to end of channels. There will be some space to allow for temperature changes.

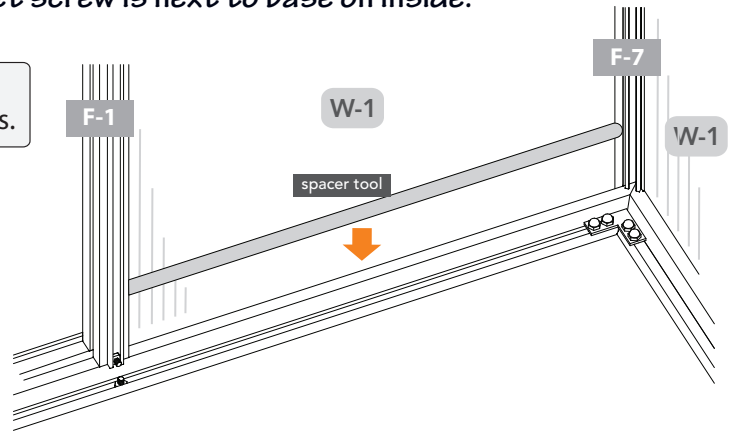

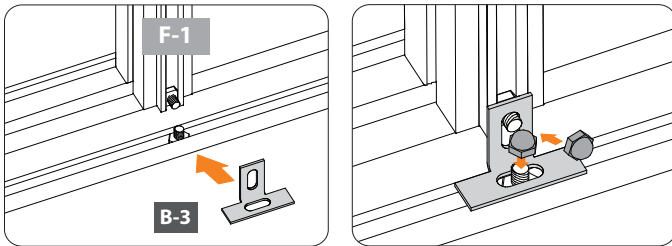

3.2C Fit B-3 connector and secure with two S-2C bolts.



NOTE: VIEWS ARE FROM INSIDE.

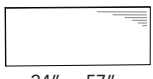

3.2D Continue building the end wall from the inside. Use the spacer with each panel and the two remaining F-1 profiles. Repeat steps 3.2A through 3.2C.

Panel		QTY	Connector		QTY
 24" x 57"	W-1	3		B-3 S-2C	3 6

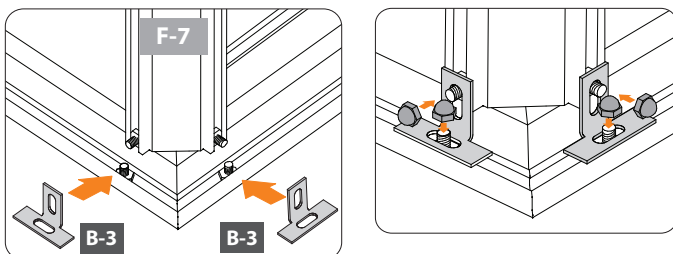
3.3 Add the last W-1 panel to complete the back. From the outside, fit F-7 corner profile into place and secure with two B-3 connectors.



NOTE: VIEWS ARE FROM OUTSIDE.

Panel		QTY	Connector		QTY
 24" x 57"	W-1	1		B-3 S-2C	2 4

3.4 The two sets of F-6 and F-10 profiles fit on top of W-1 panels. Line up bottom bolt channels with top edge of F-1 and F-7 vertical profiles. Profiles will fit snugly.

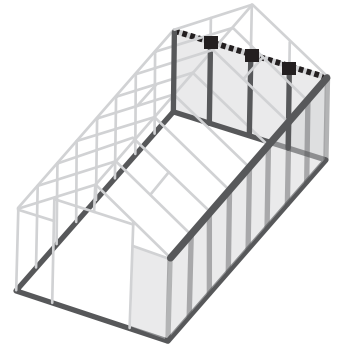

3.4A Working from inside right corner, place F-6 profile with mitered end next to corner and angled edge facing up onto corner W-1 panel. F-6 profile fits snugly between F-7 corner profile and F-1 wall profiles.

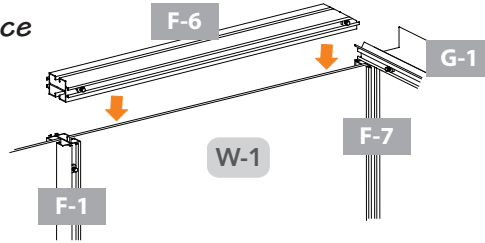

3.4B Continue along back wall. Place first F-10 profile on next W-1 panel. Make sure profile fits snugly between the two F-1 wall profiles.

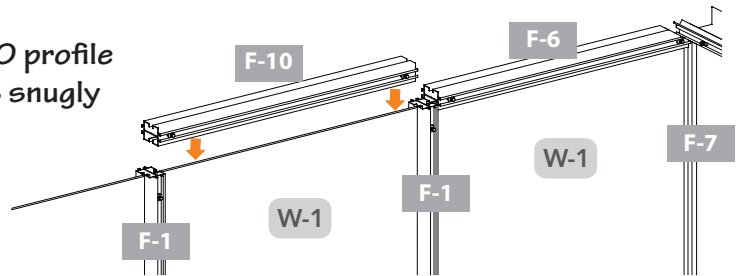

3.4C Place second F-10 profile on next W-1 and ensure it fits snugly.

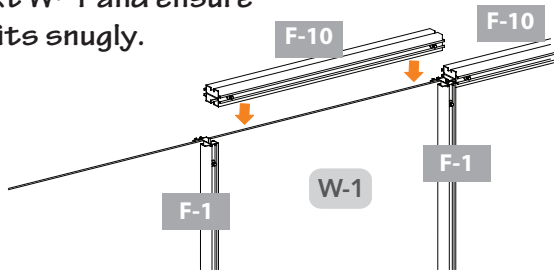

3.4D Place second F-6 profile with mitered end next to corner and angled edge facing up onto corner W-1 panel. F-6 profile fits snugly between F-7 corner profile and F-1 wall profiles.

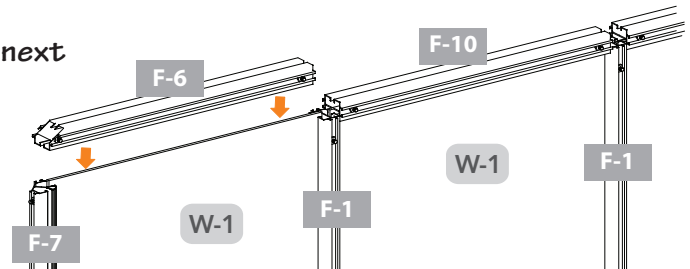

NOTE: ALL VIEWS FROM INSIDE.

3.5A From inside, loosen set screws on profiles and adjust position to fit holes in B-1 connectors. Fit B-1 connector to profiles as shown.

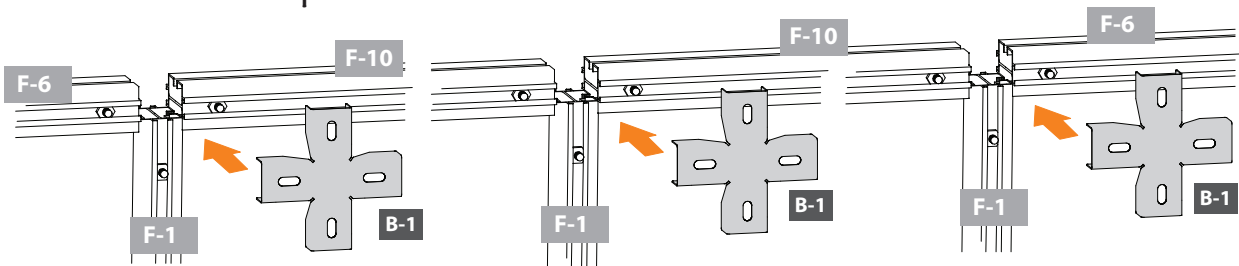

3.5B Secure each B-1 connector with three bolts.

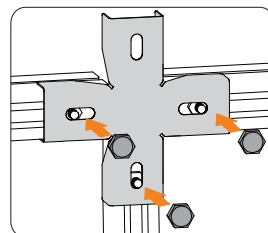

NOTE: ALL VIEWS FROM INSIDE.

Connector	QTY
B-1	3
S-2C	9

Assemble Left Wall

NOTE: Have the hex shaped indent facing up. Screw in until it is flush with bottom of nut so it slides easily into bolt tracks. After inserting into bolt track, screw in until it holds in place.

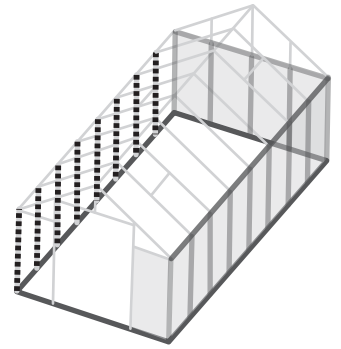

Make certain the pieces are in the correct positions before assembling. Carefully follow the order of assembly to ensure an easy installation. Wear proper safety gear including work shoes, gloves and goggles. Prepare needed set screws as shown in step 1.1A

4.1A Prepare one F-7 corner profiles. Slide set screws into all three bolt tracks on one end and into two side bolt tracks on other end of corner profile. Hand tighten each set screw to hold in place.

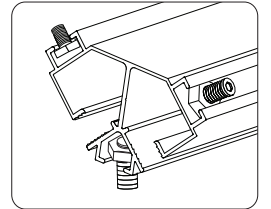
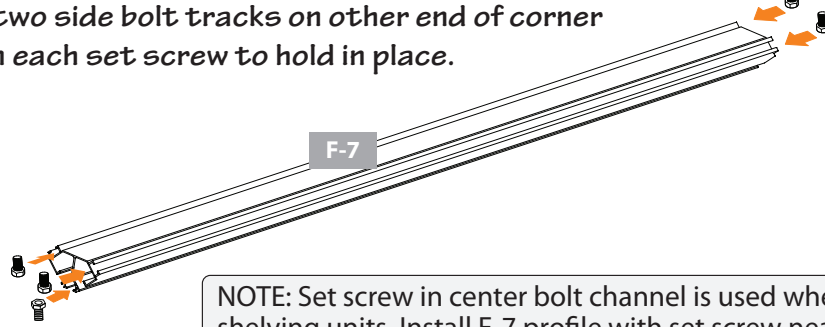
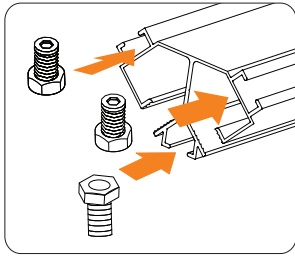

NOTE: Set screw in center bolt channel is used when installing optional shelving units. Install F-7 profile with set screw near base until needed.

4.1B Prepare seven F-1 wall profiles. Slide set screws into both bolt tracks on one end of profile and one bolt track on the other end. The single set screw will sit on the inside near the base when installed.

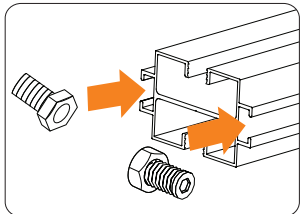
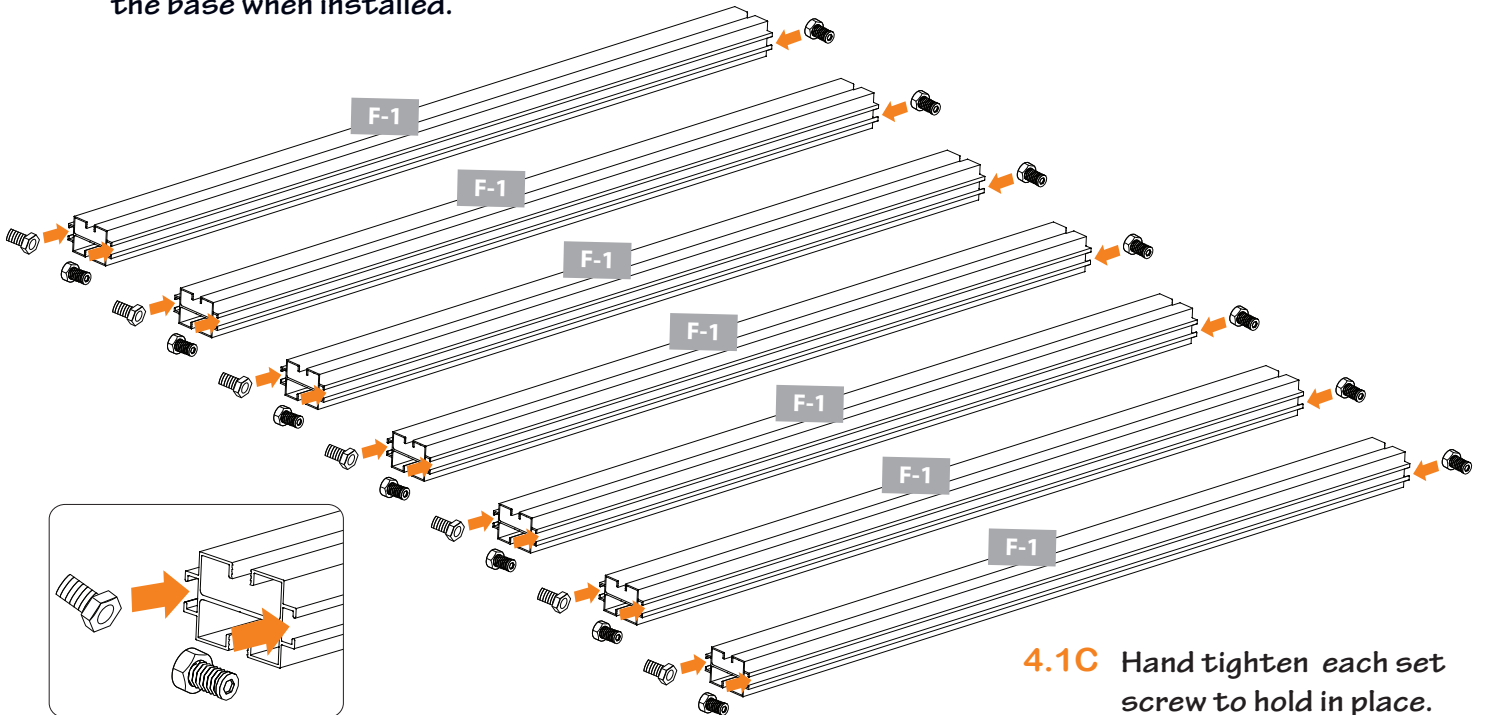

4.1C Hand tighten each set screw to hold in place.

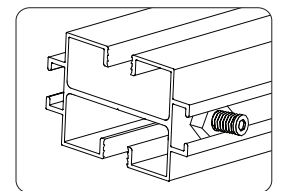

Profile	Length	Profile	QTY	Connector	QTY
	56"	F-7	1	S-2A	26
	56"	F-1	7	S-2B	26

4.2A Continue working from inside back left corner. Remove plastic film from both sides of one W-1 panel. Fit panel into channel in base and corner profile, placing side marked “UV Resistant” facing outside.

IMPORTANT: The panels expand and contract depending on the temperature. To ensure proper placement, use the 23 inch spacer included with the tools.

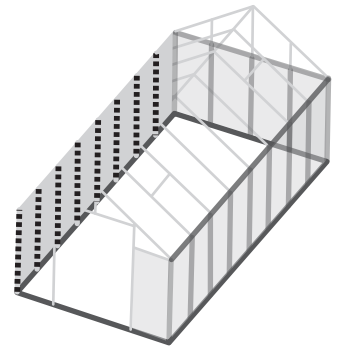

4.2B Place 23 inch spacer on base next to F-7 corner profile. Fit panel into channel in F-1 profile and slide F-1 profile against spacer to ensure proper placement. Position F-1 profiles so single set screw is next to base on inside.

NOTE: Panels will not fit completely to end of channels. There will be some space to allow for temperature changes.

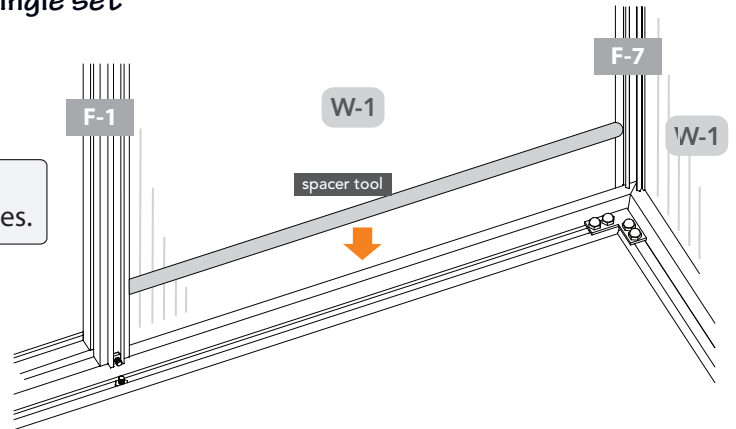

4.2C Fit B-3 connector and secure with two S-2C bolts.

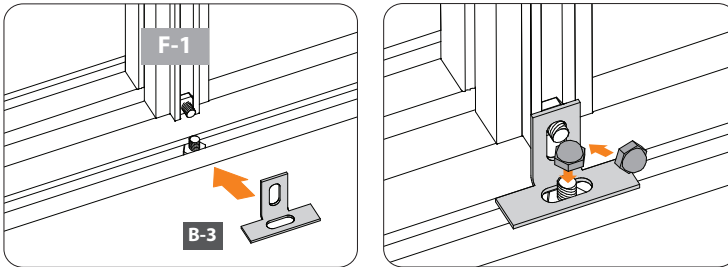



NOTE: VIEW FROM INSIDE.

4.2D Continue building the side wall from the inside. Use the spacer with each panel and the six remaining F-1 profiles. Repeat steps 4.2A through 4.2C.

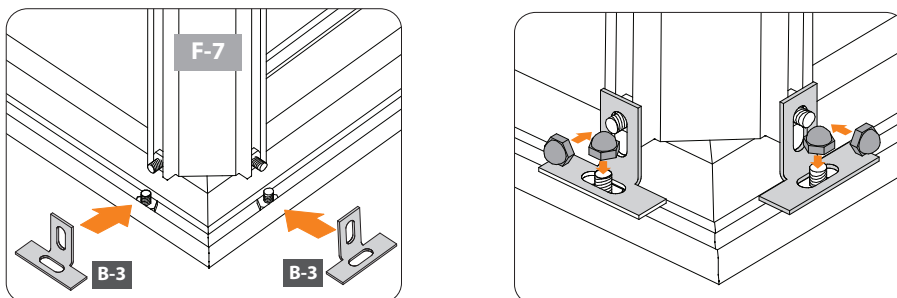
4.3 Add the last W-1 panel to complete the side. From the outside, fit F-7 corner profile into place and secure.

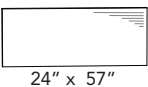

NOTE: VIEW FROM OUTSIDE.

Panel	QTY	Connector	QTY
 24" x 57"	W-1	8	 9
			 18

4.4A Prepare two G-1 gutter profiles by sliding four set screws into bottom bolt track. Hand tighten each end set screw to hold in place.

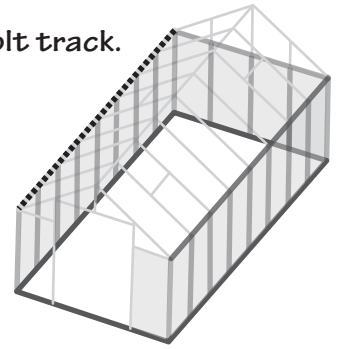
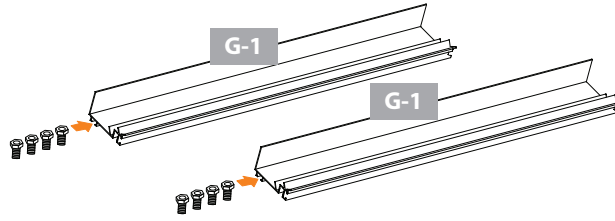
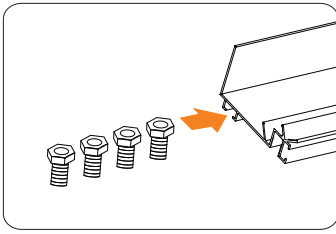

4.4B Prepare two G-2 gutter profile with six set screws and one G-2 gutter profile with five set screws. Slide set screws into bottom bolt track. Hand tighten end set screw to hold in place.

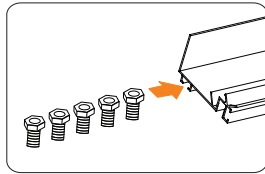
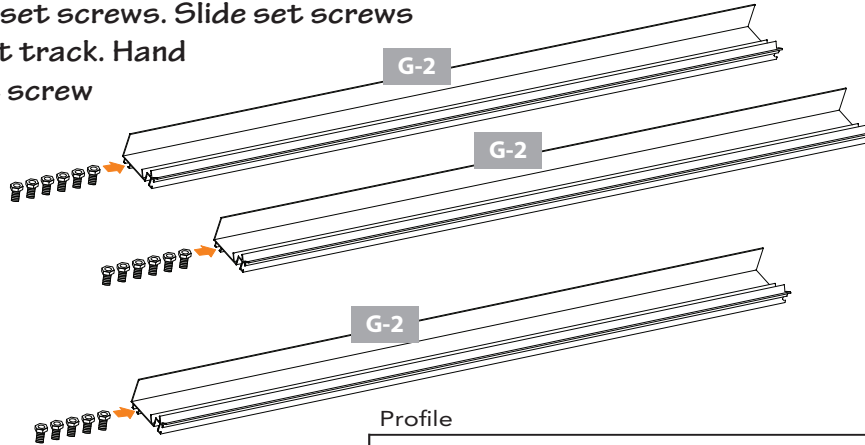
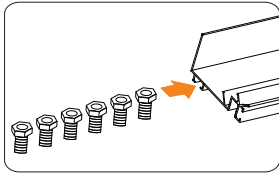

Connector			Profile	QTY	
	S-2A	25		G-1	2
	S-2B	25		G-2	3

4.5A Working from inside, place G-1 and G-2 gutter profiles, fitting top edge of W-1 panels into channels of gutters. Place one short G-1 gutter profile at each end and the three longer G-2 gutter profiles in the center. Seams are centered to bolt tracks in F-1 profiles.

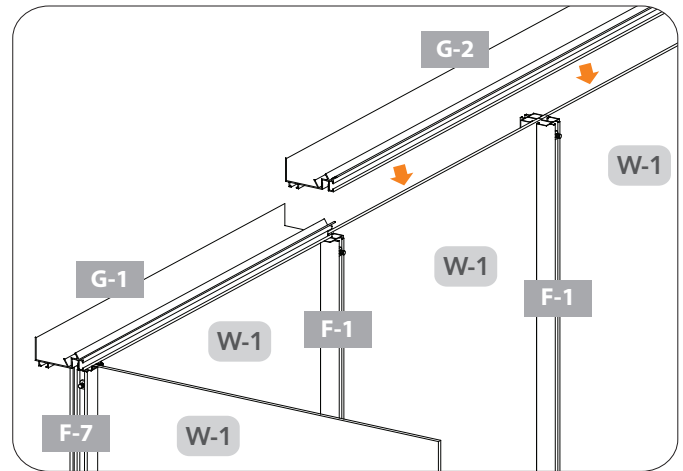
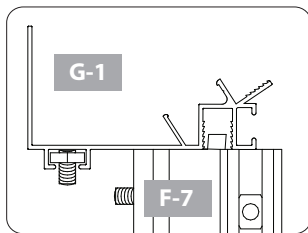

NOTE: At front and back, edge of G-1 gutter profile lines up flush with edge of F-7 corner profile.

4.5B Place one set screw on the inside bolt track of the gutter at each end. Hand tighten both set screws to hold in place.

NOTE: VIEW FROM INSIDE.

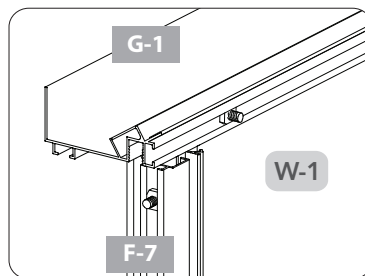
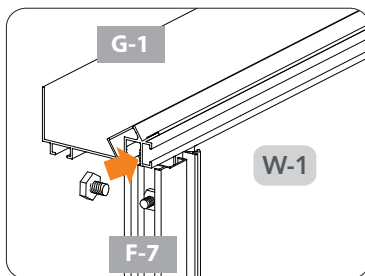

NOTE: VIEWS FROM INSIDE.

Connector			QTY
	S-2A	2	2
	S-2B	2	2

4.6A The gutters are secured together using B-5 connectors and attached to side profiles using B-3 connectors on the outside of the greenhouse. The B-3 connector uses the set screw in the center hole of B-5 connectors at seams. Loosen and slide set screws to line up with connectors making sure the seams line up and the gutters remain straight.

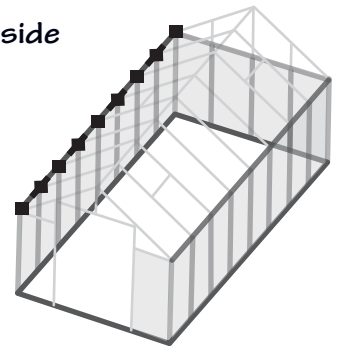

4.6B Begin at the four seams and arrange set screws so middle screw is centered. Fit B-5 connector onto gutter and hold in place using the two end bolts.

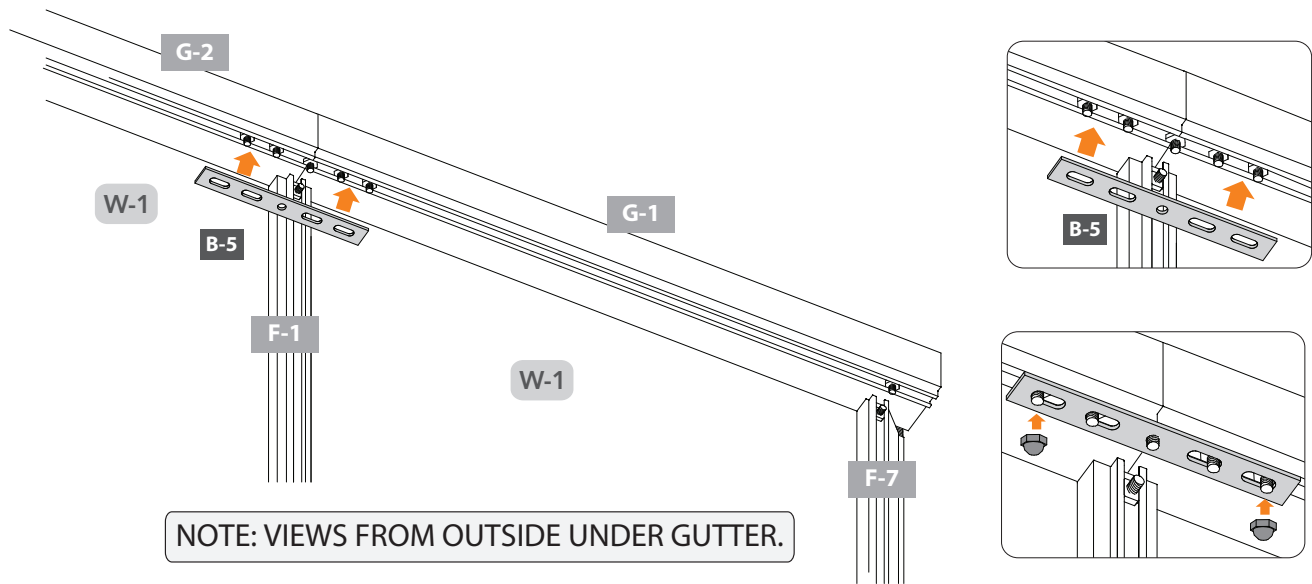

4.6C Loosen set screws on side profiles and slide down. Fit wide part of B-3 connector onto set screw, slide up into place fitting gutter set screw at other end. Tighten set screws and secure with bolts.

NOTE: The bottom of B-3 connector extends past the edges of side and corner profiles. B-3 connector sits over B-5 connector. Secure all with bolts.

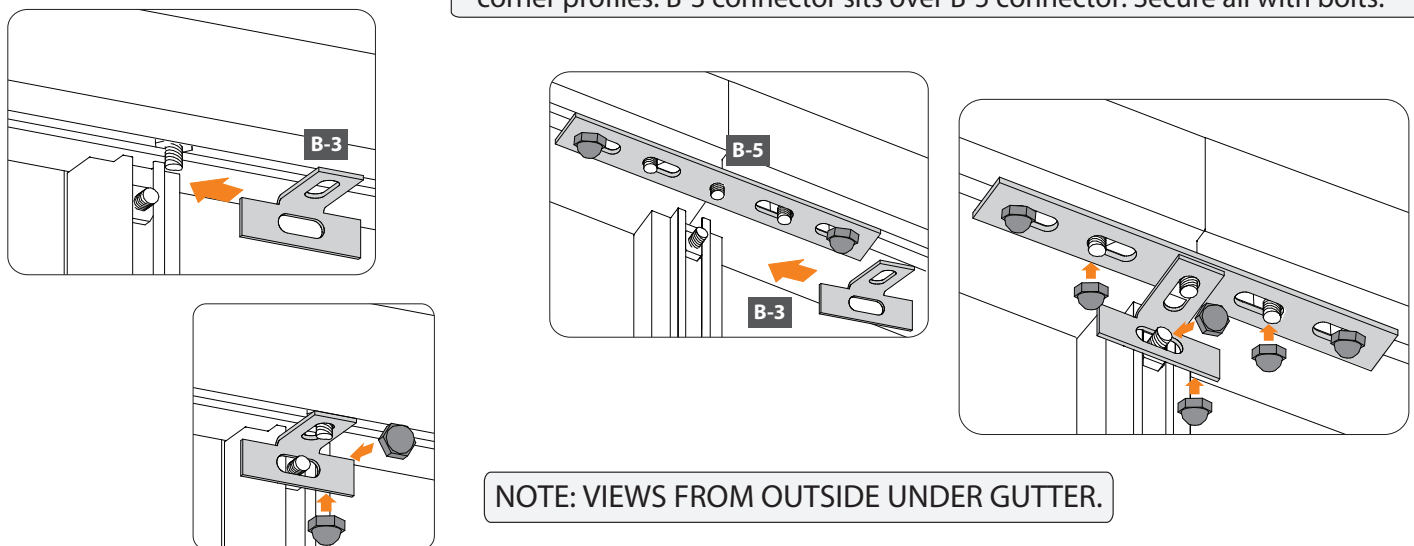

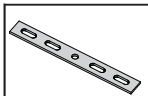
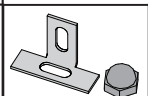
Connector	QTY	Connector	QTY
	B-5	4	
			B-3
			S-2C
			9
			34

Assemble Front Wall and Gable

NOTE: Have the hex shaped indent facing up. Screw in until it is flush with bottom of nut so it slides easily into bolt tracks. After inserting into bolt track, screw in until it holds in place.

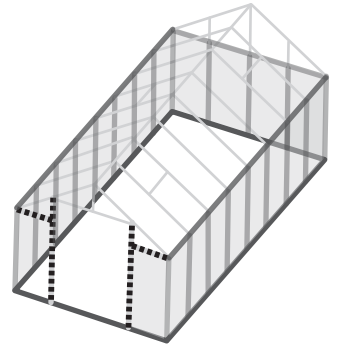

Make certain the pieces are in the correct positions before assembling. Carefully follow the order of assembly to ensure an easy installation. Wear proper safety gear including work shoes, gloves and goggles. Prepare needed set screws as shown in step 1.1A

5.1 The door frame is 65¼" high from the base. To avoid adjusting the placement after assembly, prepare door frame using the exact measurements listed in these steps.

5.1A Prepare two F-3 profiles. Slide three set screws into bolt track and position as shown.

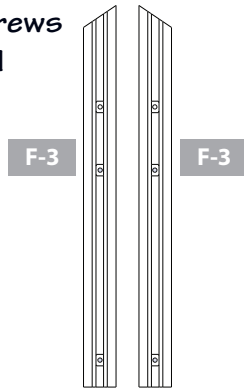
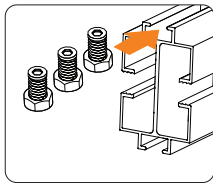

5.1B Fit B-2 connector onto profile and position so bottom of connector measures 8" from bottom of profile. Secure each with two bolts.

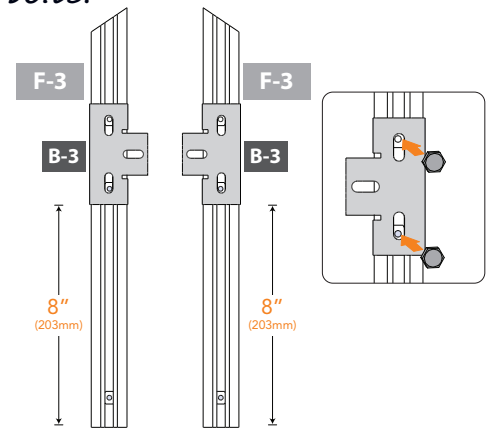





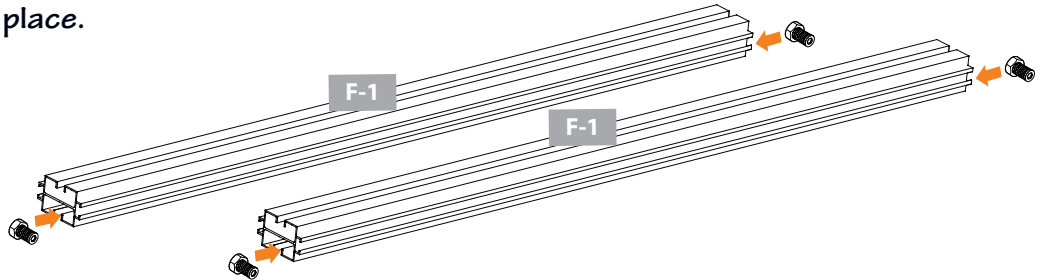
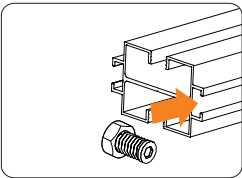

WARNING: The cut edge of F-3 profile is sharp. Use extreme caution when handling.

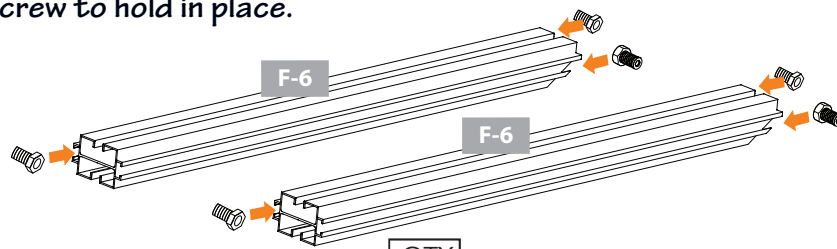
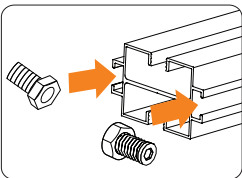
5.2A Prepare two F-1 wall profiles. Slide set screws into same bolt track, one on each end of profile. Position profile so set screw near base is on the inside when installed. Hand tighten each set screw to hold in place.



5.2B Prepare two F-6 profiles. Slide set screws into both bolt tracks on mitered end of profile and one bolt track on the other end. The single set screw will sit on the inside when installed. Hand tighten each set screw to hold in place.

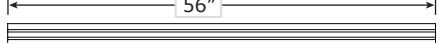
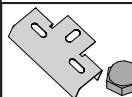

Profile	QTY	Connector	QTY	Connector	QTY
 15 7/8"	F-3	2		S-2A	16
 23"	F-6	2		S-2B	16
 56"	F-1	2		B-2	2
				S-2C	4

5.3A Working from inside front left corner, remove plastic film from both sides of one W-1 panel. Fit panel into channel in base and corner profile, placing side marked "UV Resistant" facing outside.

IMPORTANT: The panels expand and contract depending on the temperature. To ensure proper placement, use the 23 inch spacer included with the tools.

5.3B Place 23 inch spacer on base next to F-7 corner profile. Fit panel into channel in F-1 profile and slide F-1 profile against spacer to ensure proper placement.

NOTE: Panels will not fit completely to end of channels. There will be some space to allow for temperature changes.

5.3C Fit B-3 connector and secure with two S-2C bolts.

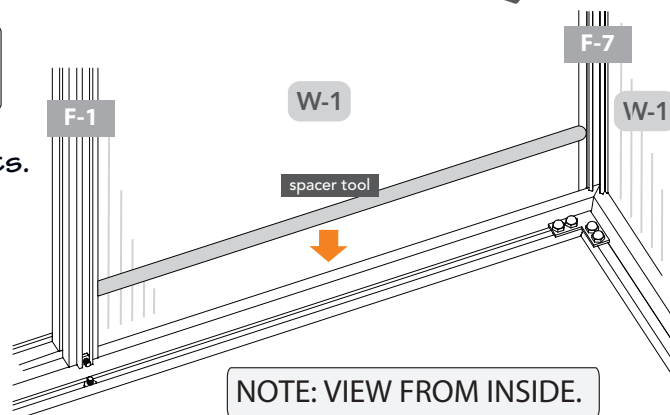
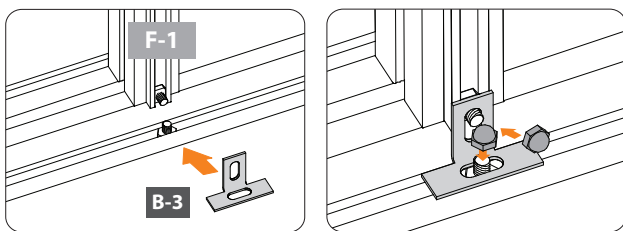

5.3D Continue working from inside left corner, place F-6 profile with mitered end next to corner and angled edge facing up onto corner W-1 panel. F-6 profile fits snugly between F-7 corner profile and F-1 wall profiles.

5.3E From inside, line up F-3 profile as shown. Make sure B-2 connector is pointing towards door opening.

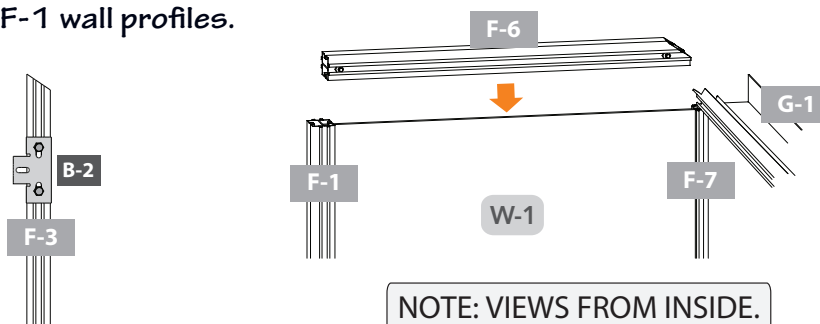

5.3F Adjust set screws and place B-2 connector on profiles as shown. Slide set screws in vertical openings to center of opening so B-6 trim plate will fit properly.





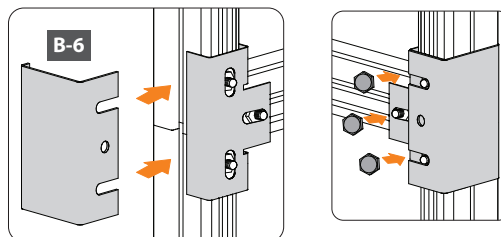
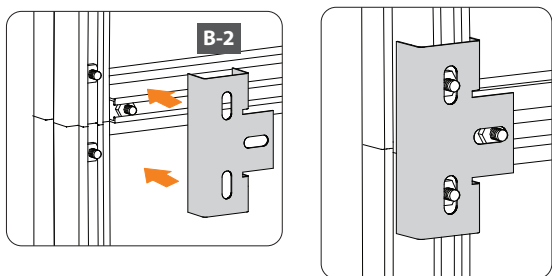

5.3G Install B-6 trim plate and secure with three bolts.

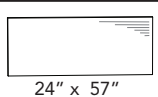

NOTE: VIEWS FROM INSIDE.

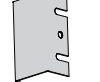
NOTE: VIEWS FROM INSIDE.

Panel	QTY	Connector	QTY	Connector	QTY	Trim Plate	QTY				
 24" x 57"	W-1	1		B-3	1		B-2	1		B-6	1
				S-2C	2		S-2C	3			

5.4A Working from inside front right corner, install F-1 profile next to W-1 panel. Place 23 inch spacer on base next to F-7 corner profile and slide F-1 profile against spacer to ensure proper placement.

IMPORTANT: The panels expand and contract depending on the temperature. To ensure proper placement, use the 23 inch spacer included with the tools.

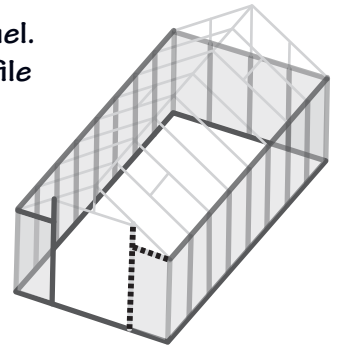
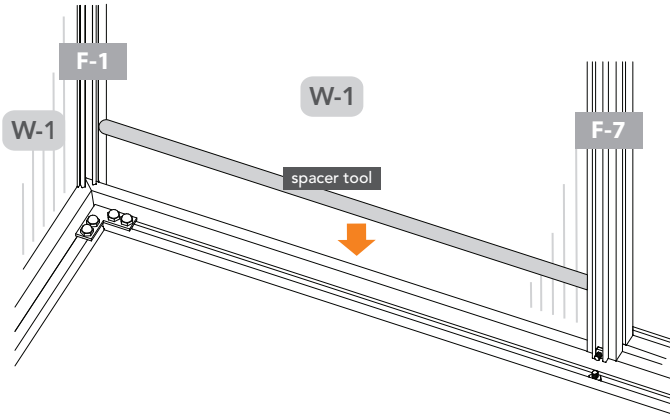

NOTE: Panels will not fit completely to end of channels. There will be some space to allow for temperature changes.

5.4B Fit B-3 connector and secure with two S-2C bolts.

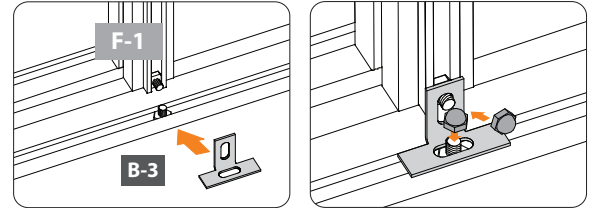

5.4C Continue working from inside right corner, place F-6 profile with mitered end next to corner and angled edge facing up onto corner W-1 panel. F-6 profile fits snugly between F-7 corner profile and F-1 wall profiles.

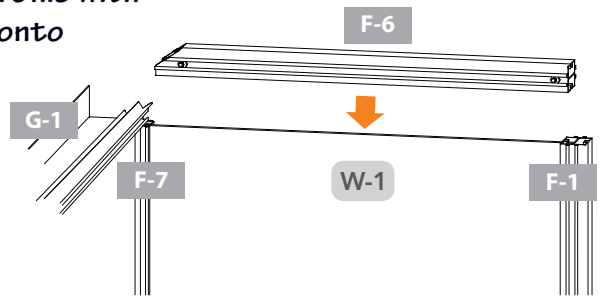

NOTE: VIEW FROM INSIDE.

5.4D From inside, line up F-3 profile as shown. Make sure B-2 connector is pointing towards door opening.

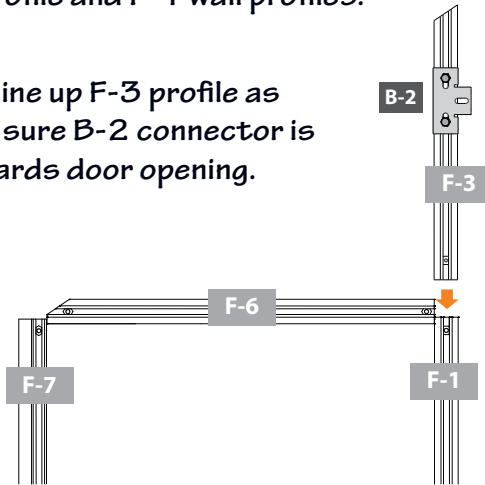

NOTE: VIEW FROM INSIDE.

5.4E Adjust set screws and place B-2 connector on profiles as shown. Slide set screws in vertical openings to center of opening so B-6 trim plate will fit properly.

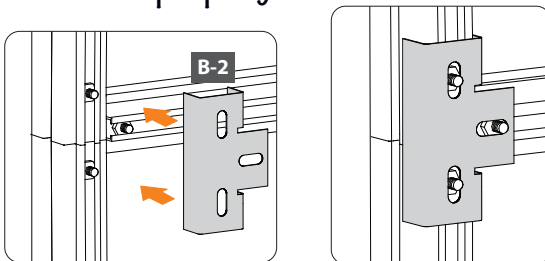

NOTE: VIEW FROM INSIDE.

5.4F Install B-6 trim plate and secure with three bolts.

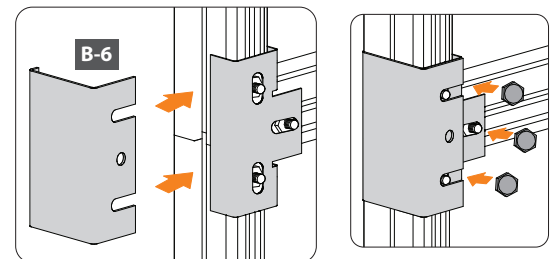

NOTE: VIEW FROM INSIDE.

Connector	QTY	Trim Plate	QTY
B-2	1	B-6	1
S-2C	3		

5.5 The door frame is 65¼" high from the base. To avoid adjusting the placement after assembly, prepare door frame using the exact measurements listed in these steps.

5.5A Prepare one F-4 profile. Slide two set screws into bolt track and position as shown.

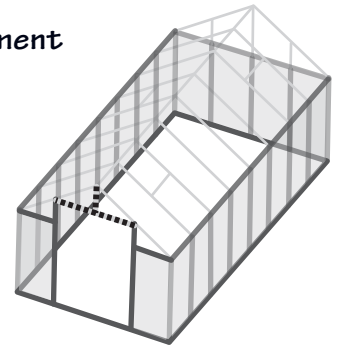
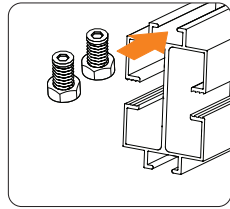

5.5B Prepare one F-5 profile. Slide four set screws into bolt tracks and position as shown.

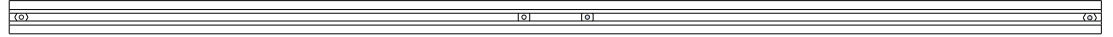
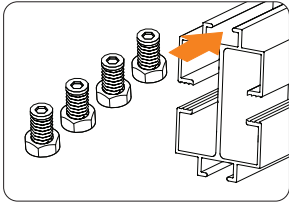



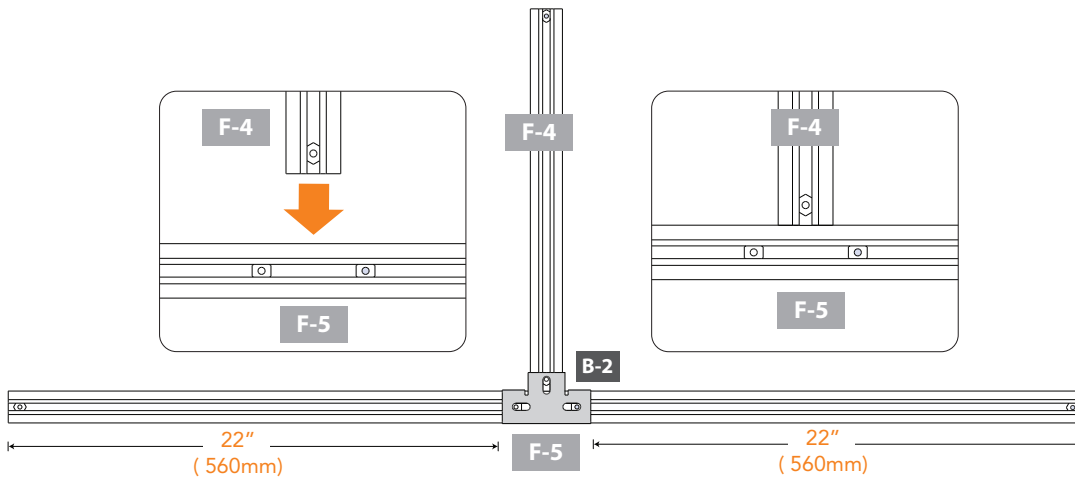



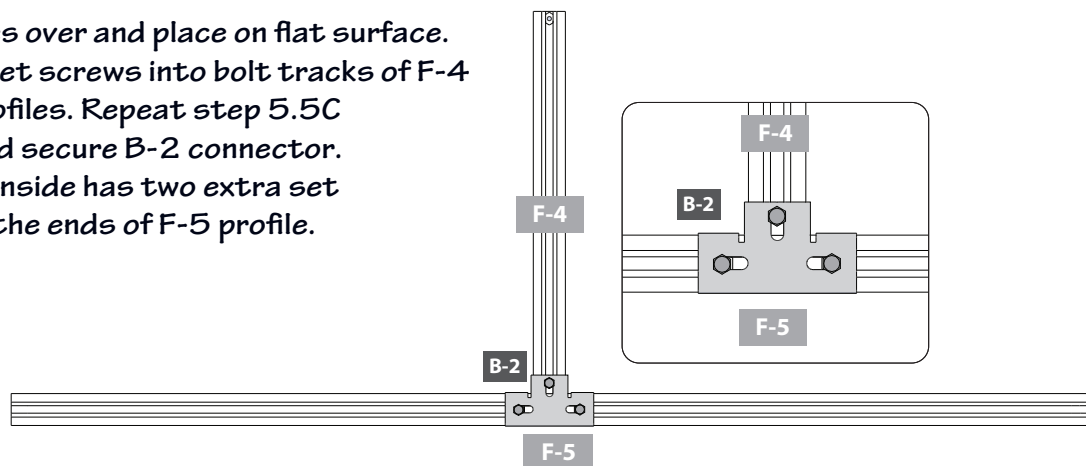

5.5C Place one end of F-4 profile against F-5 profile on flat level surface. Center F-4 profile to F-5 profile and adjust set screws to fit B-2 connector. Secure with three bolts.

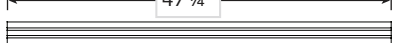
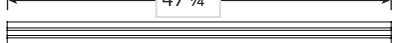

IMPORTANT: F-4 profile is centered to F-5 profile and secured on both sides with B-2 connector.

5.5D Turn profiles over and place on flat surface. Slide two set screws into bolt tracks of F-4 and F-5 profiles. Repeat step 5.5C to place and secure B-2 connector. **NOTE:** The inside has two extra set screws on the ends of F-5 profile.



Profile		QTY	Connector	QTY	Connector	QTY
		F-4	1		S-2A	10
		F-5	1		S-2B	10
					B-2	2
					S-2C	6

5.6A Working from inside, remove plastic film from both sides of two W-3 panels. Fit each panel into channels in profiles, placing side marked "UV Resistant" facing outside.

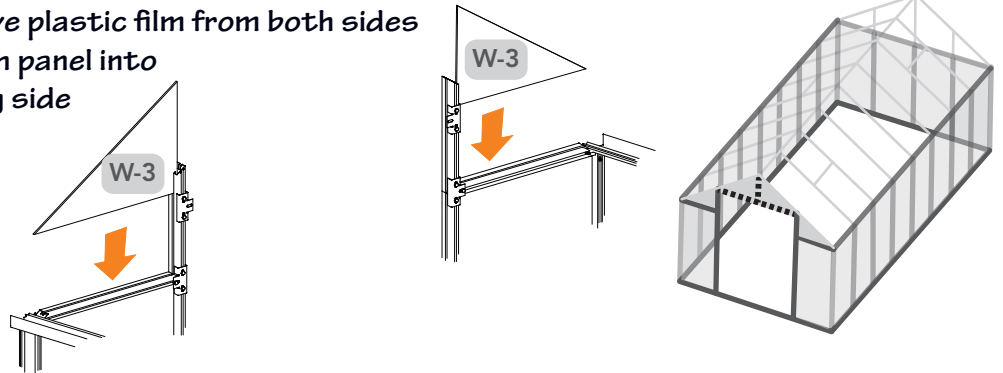

WARNING: The corners of W-3 panels are sharp. Use extreme caution when handling.

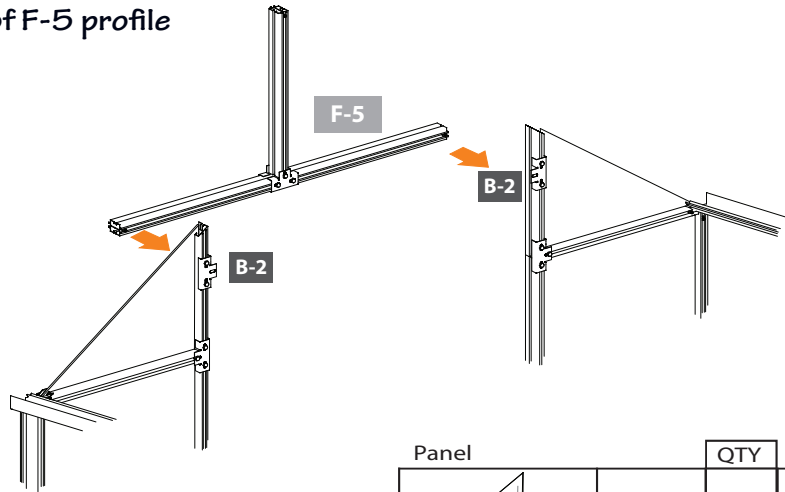
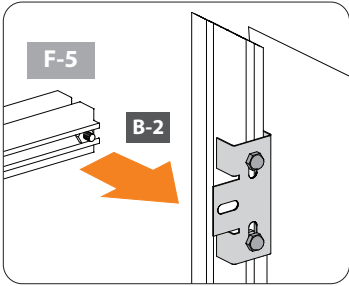

5.6B Continue working from inside, install door frame. Loosen set screws on ends of F-5 profile and adjust position to fit holes in B-2 connector.

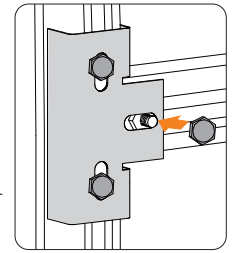

5.6C Secure with two bolts. Ensure height to base is 65¼".



NOTE: VIEWS FROM INSIDE.

Panel	QTY	Connector	QTY	
 24" x 15½"	W-3	2	 S-2C	2

5.7 Remove plastic film from both sides of two W-5 panels. Fit each panel into channels in profiles, placing side marked "UV Resistant" facing outside.

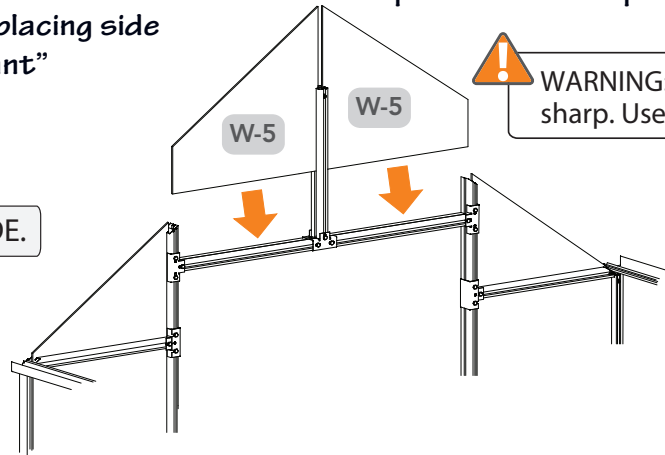

WARNING: The corners of W-5 panels are sharp. Use extreme caution when handling.

NOTE: VIEWS FROM INSIDE.

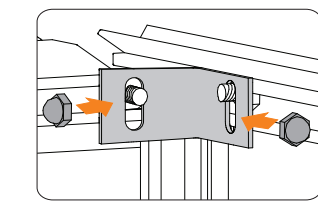
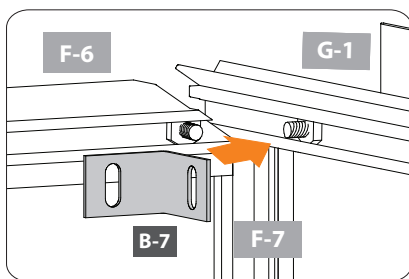

Panel	QTY	
 24" x 21¾"	W-5	2

5.8 From inside, add connector B-7 to each corner. Secure each with two bolts.



IMPORTANT: Bolt track of F-6 front profile is lower than bolt track of G-1 gutter profile.

NOTE: VIEWS FROM INSIDE.

Connector	QTY
 B-7	2
 S-2C	4

5.9A Prepare two F-7 corner profiles. Slide three set screws into the same bolt track, two on one end and one on other end of profile. Position one set screw in center of profile. It will be used in a later step. Tighten each set screw to hold in place.

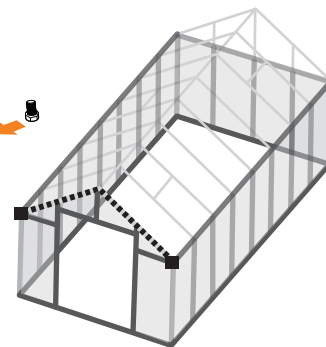
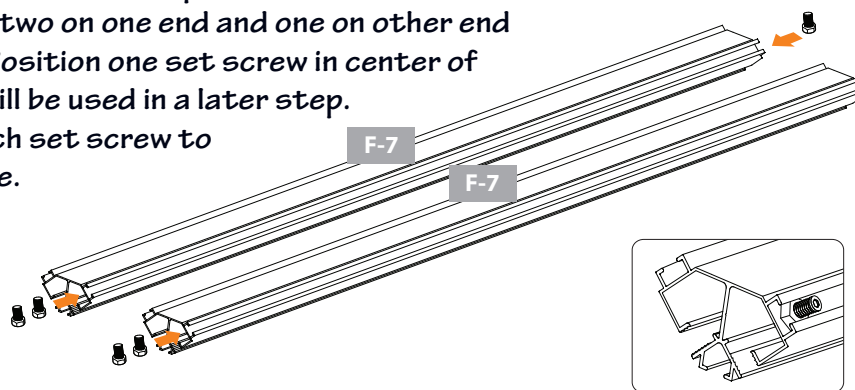
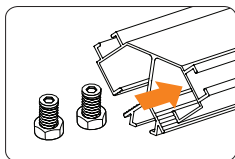

5.9B From outside fit F-7 profiles into each side of front. Begin with either side. Arrange F-7 profile so channel lines up with tops of panels and the set screws are facing out. The side of the profile rests against cut angle of F-3 profile. The top end touches edge of F-4 center profile and bottom end touches top of G-1 gutter. Position both F-7 profiles.

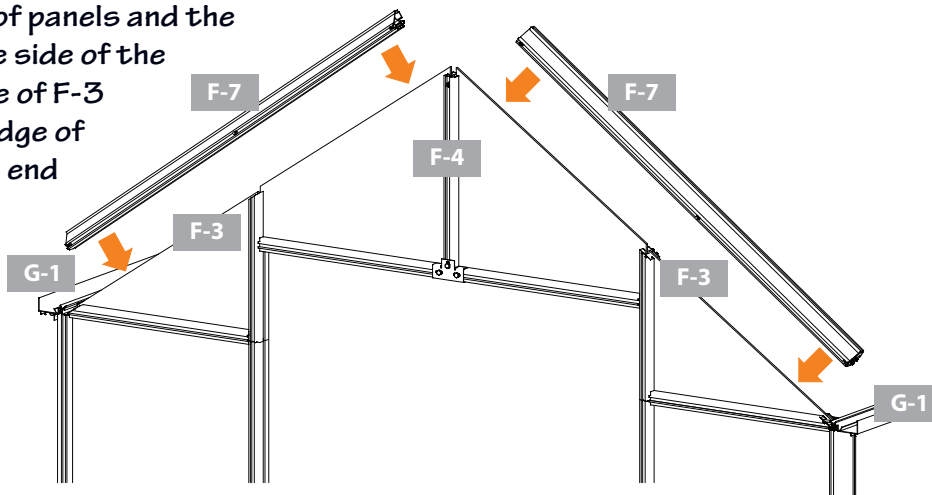

NOTE: VIEW FROM OUTSIDE.

5.9C Use C-1 connector to secure each outside corner. Loosen set screws on profiles and adjust position to fit holes in C-1 connectors. Make sure all profiles line up flush against each other. Secure with bolts. Repeat on other side.

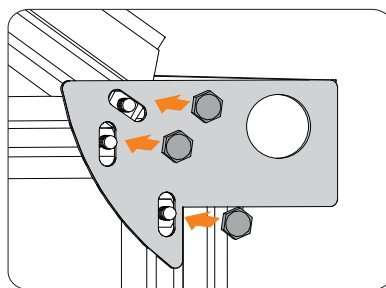
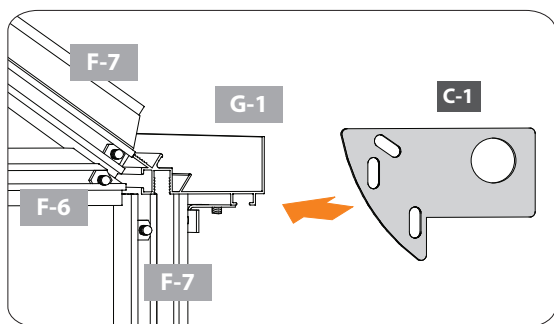



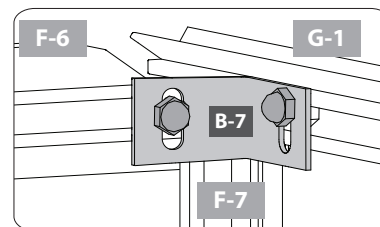

NOTE: VIEWS FROM INSIDE.

5.9D Check inside corners to ensure B-7 connector is still in proper position. If it needs adjusting, repeat steps 5.8 and 5.9C through 5.9D until each corner is set.

NOTE: VIEW FROM INSIDE.

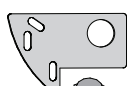

Profile	QTY	Connector	QTY	Connector	QTY	
 56"	F-7	2	 S-2A	6	 C-1	2
			 S-2B	6	 S-2C	6

Assemble Back Wall

NOTE: Have the hex shaped indent facing up. Screw in until it is flush with bottom of nut so it slides easily into bolt tracks. After inserting into bolt track, screw in until it holds in place.

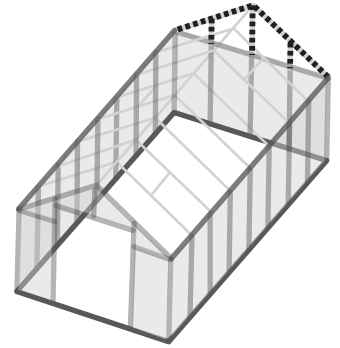

Make certain the pieces are in the correct positions before assembling. Carefully follow the order of assembly to ensure an easy installation. Wear proper safety gear including work shoes, gloves and goggles. Prepare needed set screws as shown in step 1.1A

6.1A Prepare two F-7 corner profiles. Slide set screws into the same bolt track, one on each end of profile. Tighten each set screw to hold in place.

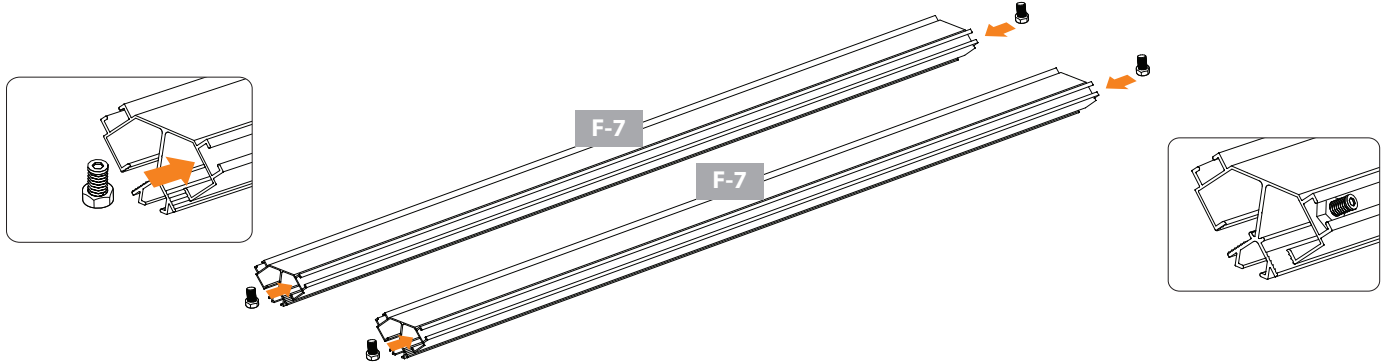

6.1B Prepare one F-2 profile. Slide set screws into both bolt tracks on each end of profile. Tighten each set screw to hold in place.

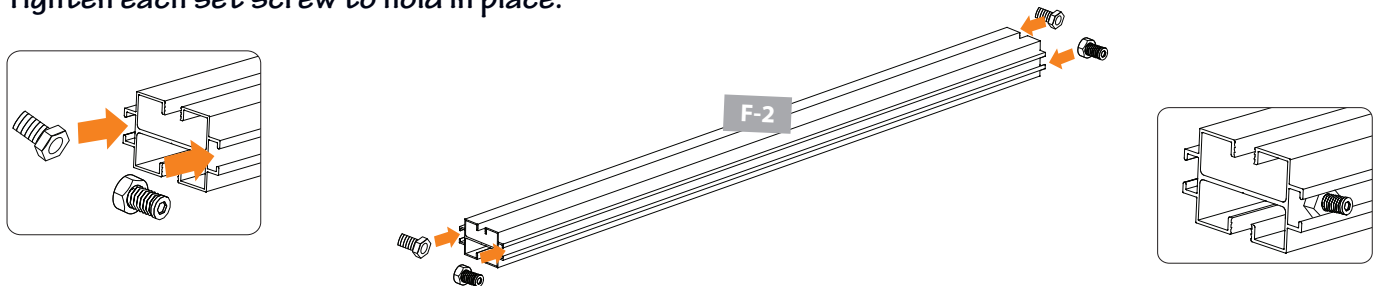

6.1C Prepare two F-3 profiles. Slide set screws into both bolt tracks on straight end of F-3 profiles. Tighten each set screw to hold in place.

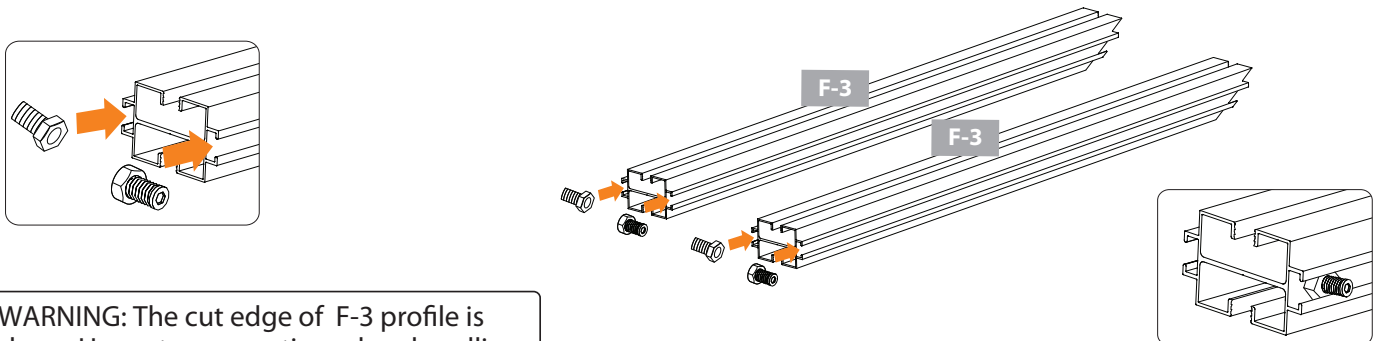

WARNING: The cut edge of F-3 profile is sharp. Use extreme caution when handling.

Profile	QTY	Connector		QTY
	F-3	2		16
	F-2	1		16
	F-7	2		

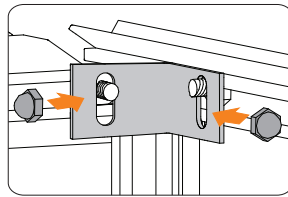
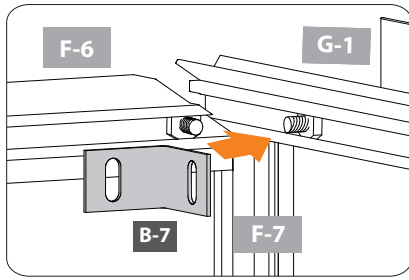

6.2 From inside, add connector B-7 to each corner. Secure each with two bolts.

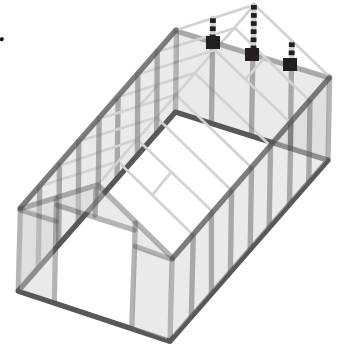

IMPORTANT: Bolt track of F-6 front profile is lower than bolt track of G-1 gutter profile.



NOTE: VIEWS FROM INSIDE.

Connector		QTY
	B-7	2
	S-2C	4

6.3A Continue working from inside. Line up F-2 and F-3 profiles with F-1 profiles as shown. Loosen set screws and adjust position to fit holes in B-1 connectors. Make sure profiles are straight.

6.3B Secure with bolt in each B-1 connector.

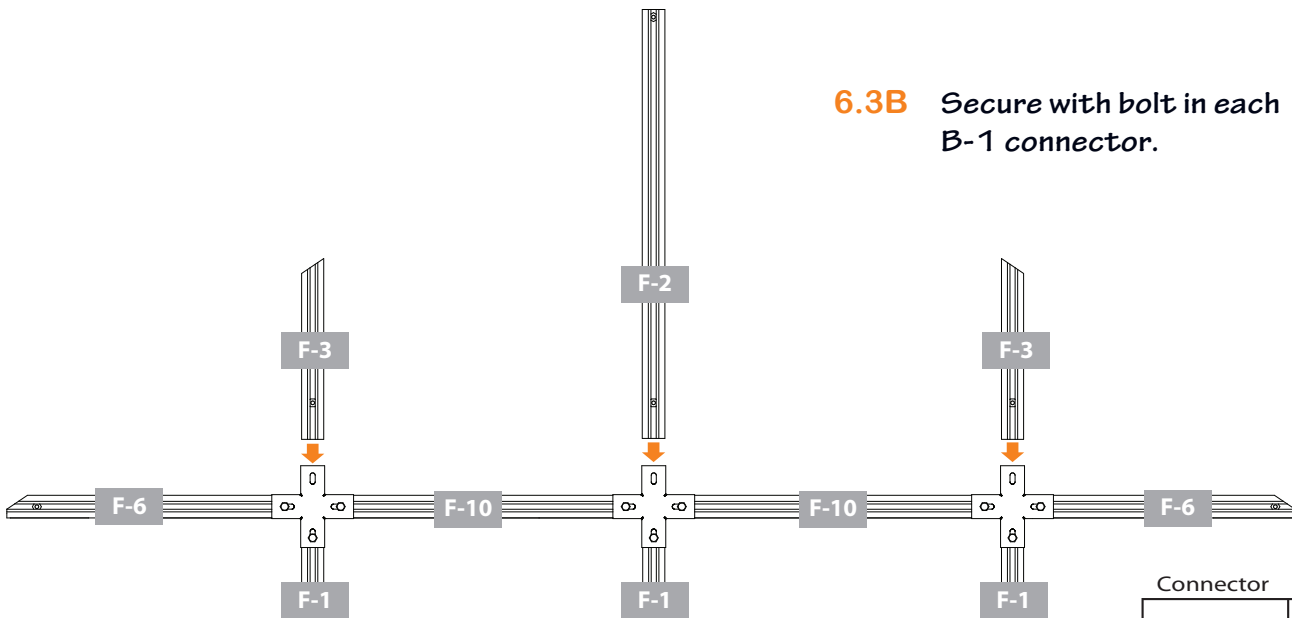

NOTE: VIEW FROM INSIDE.



Connector		QTY
	S-2C	3

6.4A Work from outside to add B-1 connectors in the same position. Loosen set screws on profiles and adjust position to fit holes in B-1 connectors. Fit B-1 connector to profiles as shown.

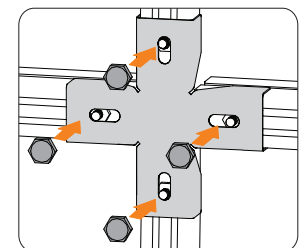
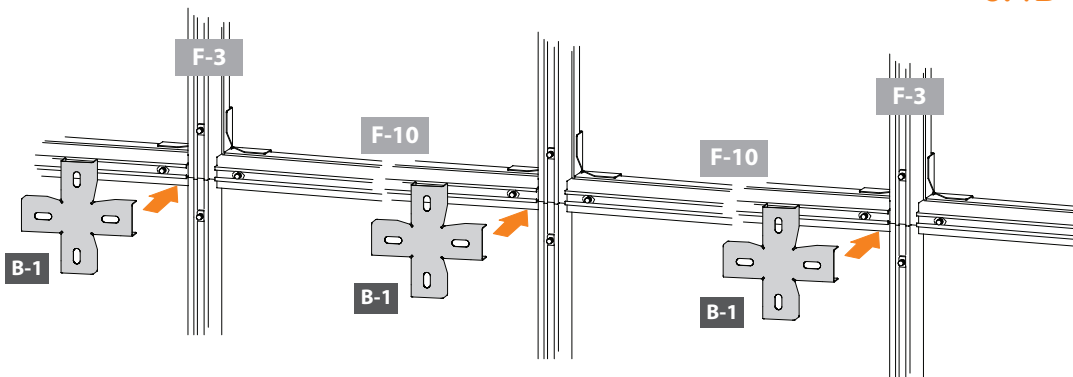
6.4B Secure each B-1 connector with four bolts.



NOTE: VIEW FROM OUTSIDE.

Connector		QTY
	B-1	3
	S-2C	12

6.5 Continue working from outside to install panels as shown. Remove plastic film from both sides of two W-3 and two W-4 panels. Fit each panel into channel in profiles, placing side marked "UV Resistant" facing outside.

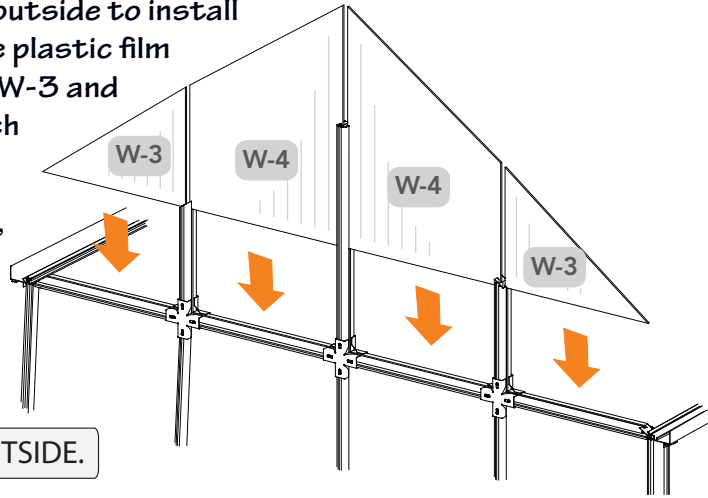

NOTE: VIEW FROM OUTSIDE.

! WARNING: The corners of W-3 and W-4 panels are sharp. Use extreme caution when handling.

NOTE: Panels will not fit completely to end of channels. There will be some space to allow for temperature changes.

Panel	QTY	Panel	QTY		
24" x 15 1/4" 	W-3	2	24" x 30 3/4" 	W-4	2

6.6A From outside fit F-7 profiles into each side of back. Arrange the profile so channel lines up with tops of panels and the set screws on each end are visible. Begin with either right or left side. Profile side fits against cut angle of F-3 profile. One end touches top of gutter and the top end touches edge of F-2 center profile. Position both F-7 profiles.

NOTE: VIEW FROM OUTSIDE.

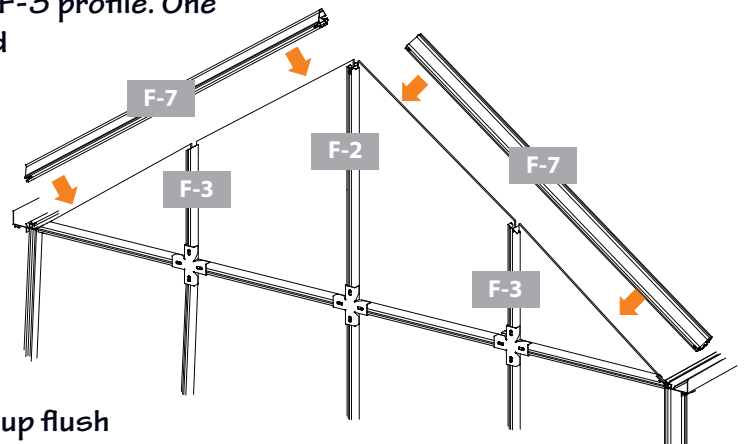

6.6B Use C-1 connector to secure each outside corner. Loosen set screws on profiles and adjust position to fit holes in C-1 connectors. Make sure all profiles line up flush against each other. Secure with three bolts. Repeat on other side.

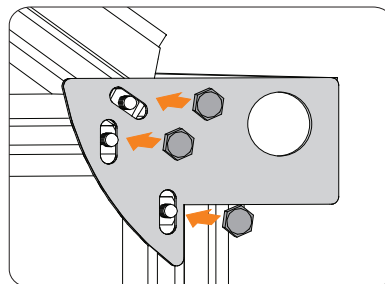
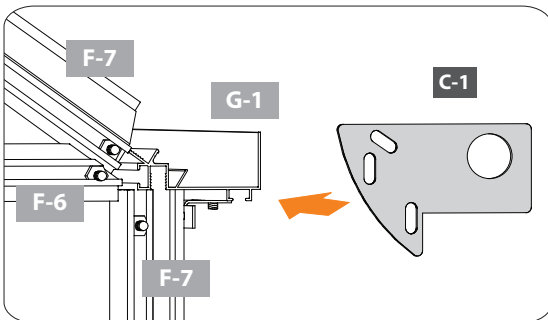

NOTE: VIEW FROM OUTSIDE.

6.6C Check inside corners to ensure B-7 connector is still in proper position. If it needs adjusting, repeat steps 6.6B and 6.6C until each corner is set.

NOTE: VIEW FROM INSIDE.

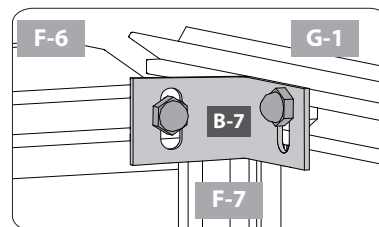

Connector	QTY	
	C-1	2
	S-2C	6

Assemble Roof Ridge

NOTE: Have the hex shaped indent facing up. Screw in until it is flush with bottom of nut so it slides easily into bolt tracks. After inserting into bolt track, screw in until it holds in place.

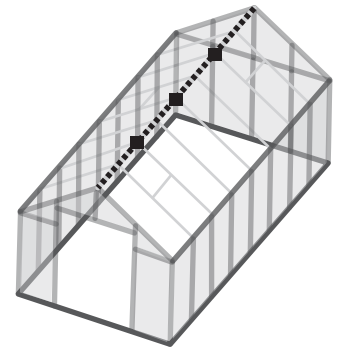

Make certain the pieces are in the correct positions before assembling. Carefully follow the order of assembly to ensure an easy installation. Wear proper safety gear including work shoes, gloves and goggles. Prepare needed set screws as shown in step 1.1A

7.1 Prepare the two R-1 and two R-1E roof profiles. They will line up in a row and joined using three B-5 connectors using a total of fourteen set screws and three long hex bolts. Arrange profile so bolt track is facing up.

7.1A Slide set screws into bolt track on each end of profile as shown.

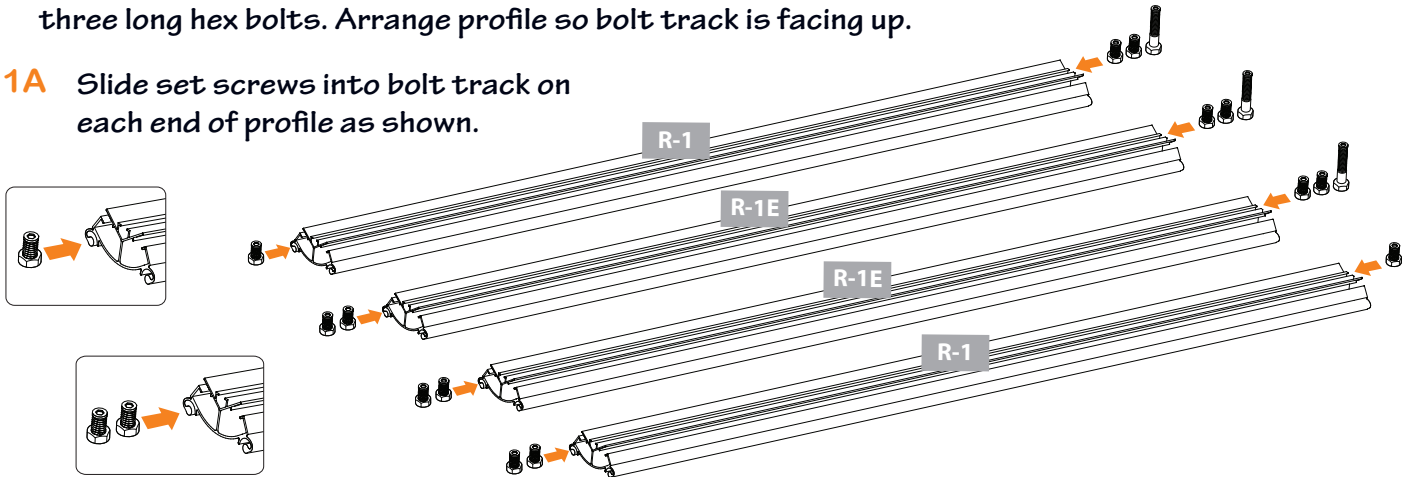

7.1B Line up four profiles in a straight line with R-1E profiles in the middle. Hand tighten set screw on each end of R-1 profile to hold in place.

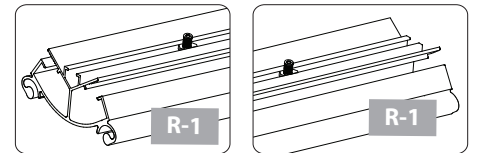



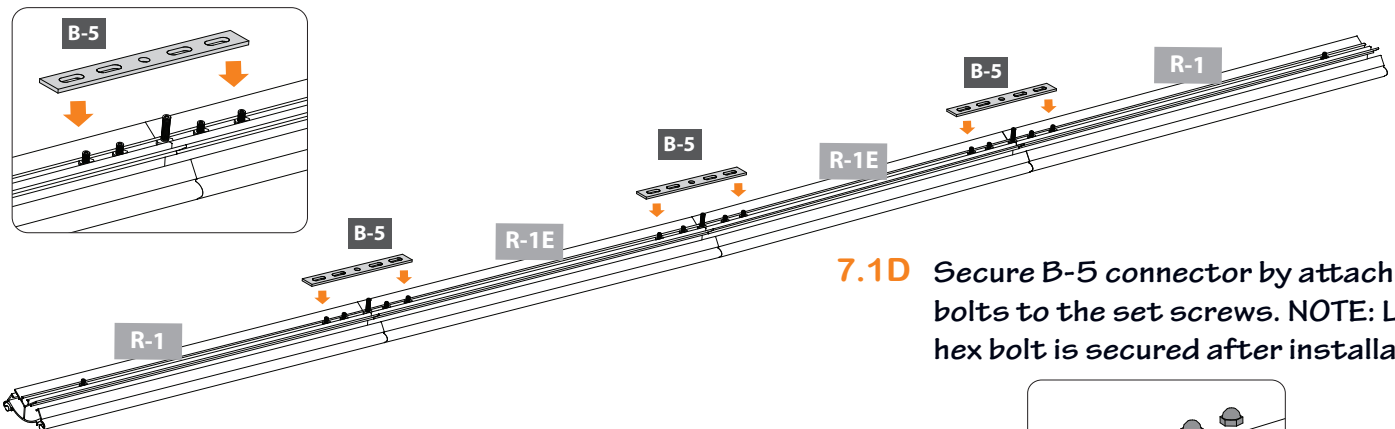

7.1C Adjust position of set screws and long hex bolt to fit holes in B-5 connector. Position each B-5 connector with the long hex bolt in center hole, and center to the seam where the profiles join.

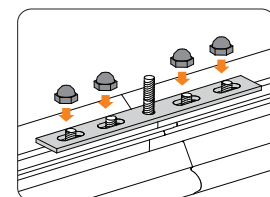

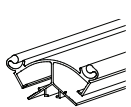
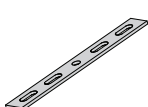
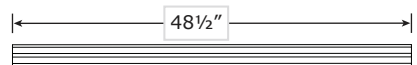
7.1D Secure B-5 connector by attaching bolts to the set screws. NOTE: Long hex bolt is secured after installation.



Profile		QTY	Connector	QTY	Connector	QTY
	49 ³ / ₄ "	R-1	2		B-5	4
	48 ¹ / ₂ "	R-1E	2		S-2A	14
					S-2B	14
					S-5A	3

7.2A Use two people and a step ladder. Place step ladder inside greenhouse. Have one person inside greenhouse supporting ridge as you slide it into position. Avoid touching top of front and back of greenhouse until each end is flush with ends of front and back profiles.

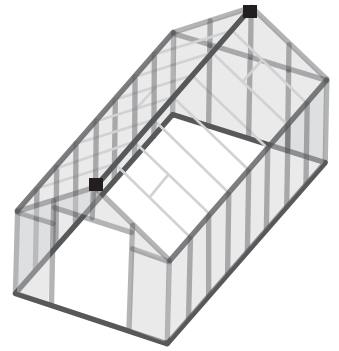

WARNING: Use two people to install roof ridge. Place ladder in inside of greenhouse. One person will stand on the ladder holding the ridge until it is in the proper position and secured in place.

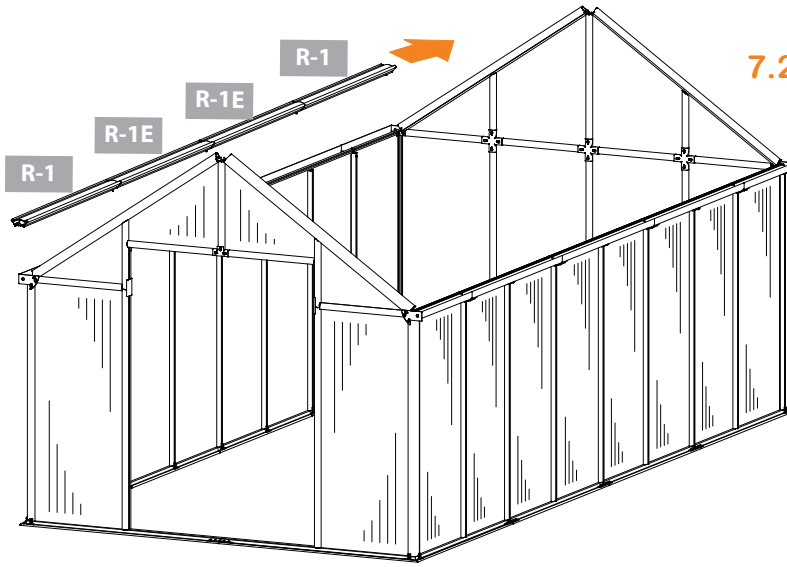

7.2B Make sure end of roof ridge is flush to profiles on front and back.

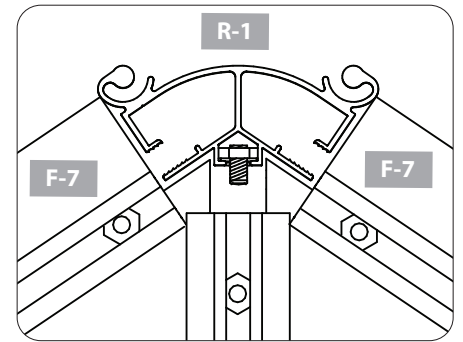

7.3A Working from inside, secure roof ridge to front end wall. Loosen set screws and adjust position to fit holes in B-7 connector. Secure with two bolts.

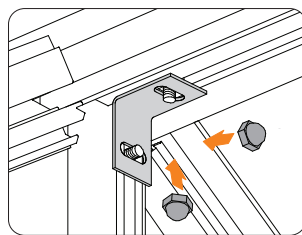
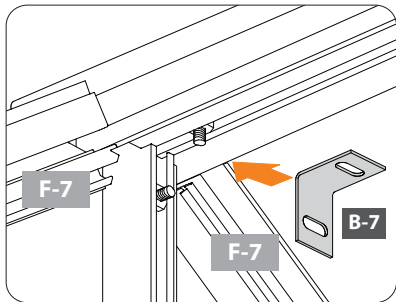

NOTE: VIEWS FROM INSIDE.

7.3B Repeat step 7.3A to secure back.

Connector	QTY
B-7	2
S-2C	4

7.4A Working from outside, ensure all pieces are still flush and secure roof ridge to front. Loosen set screws and adjust position to fit holes in C-2 connector. Secure with three bolts.

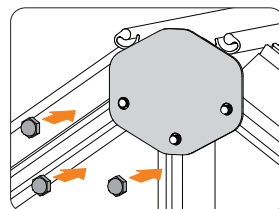
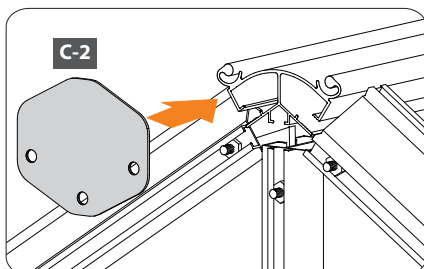

NOTE: VIEWS FROM OUTSIDE.

7.4B Repeat step 7.4A to secure back.

Connector	QTY
C-2	2
S-2C	6

Assemble Roof

NOTE: Have the hex shaped indent facing up. Screw in until it is flush with bottom of nut so it slides easily into bolt tracks. After inserting into bolt track, screw in until it holds in place.

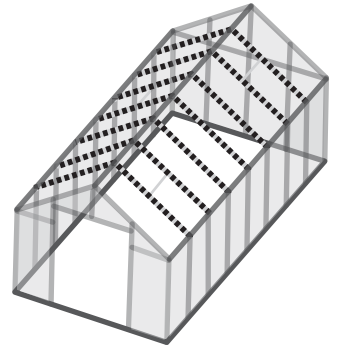

Make certain the pieces are in the correct positions before assembling. Carefully follow the order of assembly to ensure an easy installation. Wear proper safety gear including work shoes, gloves and goggles. Prepare needed set screws as shown in step 1.1A

8.1A Prepare all profiles for roof. Prepare eight F-1 profiles. Slide one set screw into bolt track on each end of profile. Tighten to hold in place.

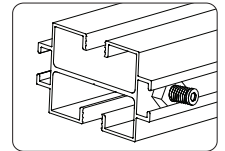
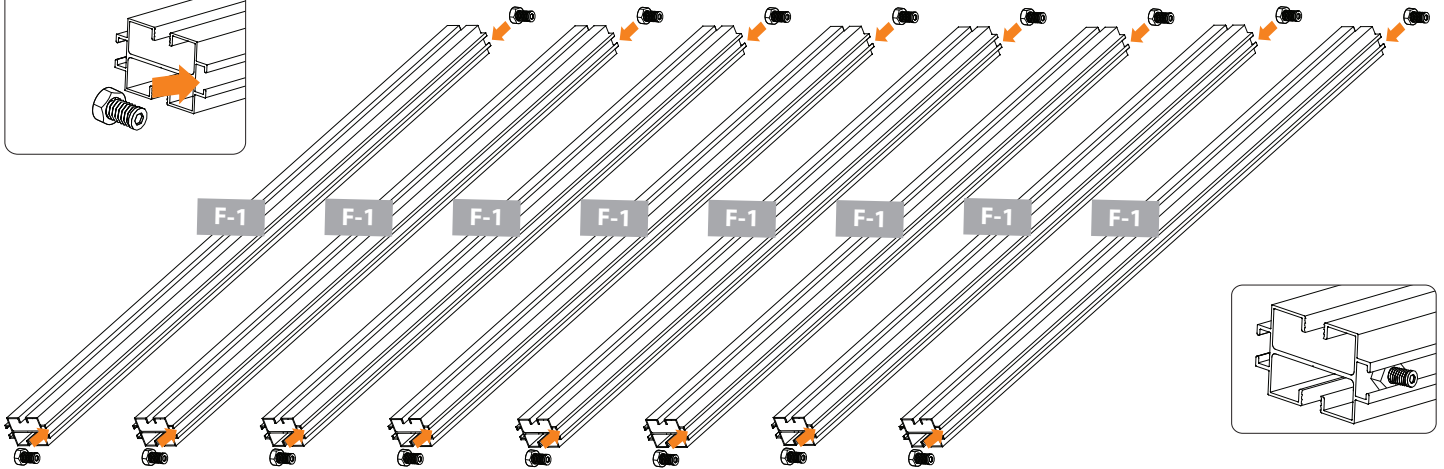
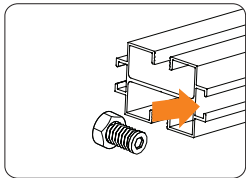

8.1B Prepare six F-1 profiles to be used with braces. Slide two set screws into bolt track on one end and one set screw on the other end of profile.

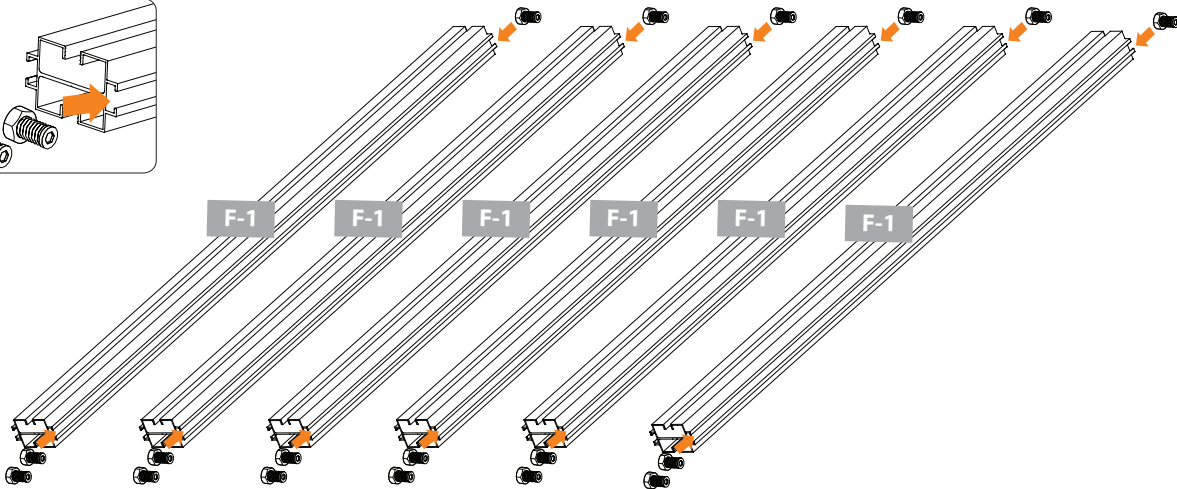
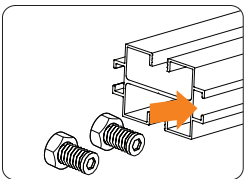

8.1C Measure 19 5/8 inches from one side of profile. Slide middle set screw to that point and tighten to hold in place. Tighten the other two set screws on each end of profile.



Profile	QTY	Connector	QTY
	F-1	S-2A	34
		S-2B	34

8.2 The roof panels are installed in the sections shown below. Use two people and a step ladder to assemble the roof. Place step ladder inside greenhouse. Have one person stand on ladder inside and guide panel into channels in roof ridge and corner profiles. The other person supports the end of the panel from the outside.

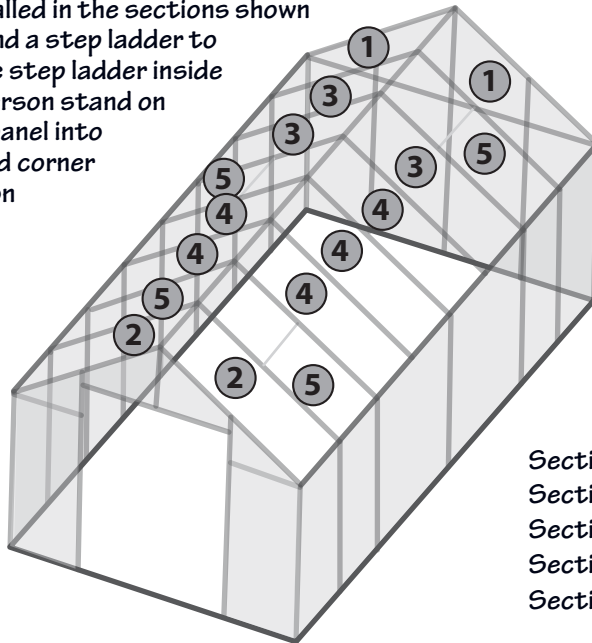

- Section 1: Back two W-1 panels
- Section 2: Front two W-1 panels
- Section 3: Next three W-1 panel from back
- Section 4: Next five W-1 panels
- Section 5: Final W-1 panel and three W-2 panels

WARNING: Use two people to install roof. Allow enough time to complete this step and install and secure roof. Do not leave roof unattended until it is completely assembled.

IMPORTANT: The panels expand and contract depending on the temperature. Under some conditions, the panels may require slight force to install. Do not use excessive force or you may move profiles out of position. When you are having difficulty sliding the panels, use dish soap with water on the edges as a lubricant.

NOTE: Use the included five foot bungee cords for added support. They will help hold the sides in position while assembling the roof. Remove as you install profiles.

8.2A Working from the inside, install B-4 connector on every other side profile on both sides of greenhouse. Secure each with one bolt.

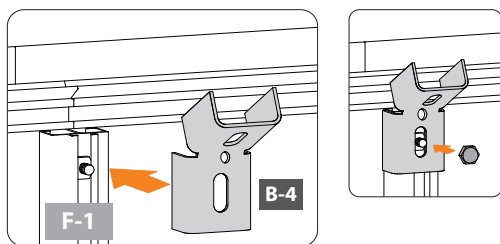

NOTE: VIEWS FROM INSIDE.

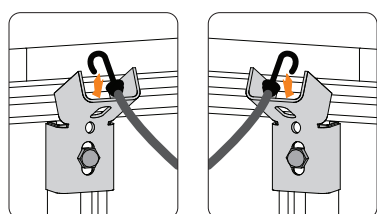

8.2B Hook one end of bungee cord into top hole in B-4 connector on each side.

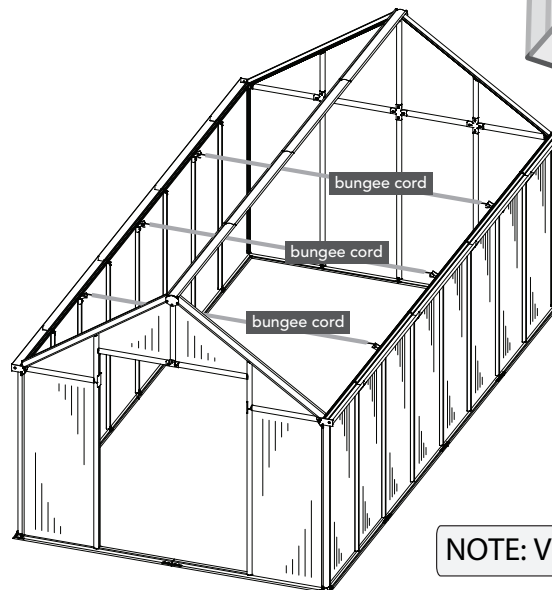
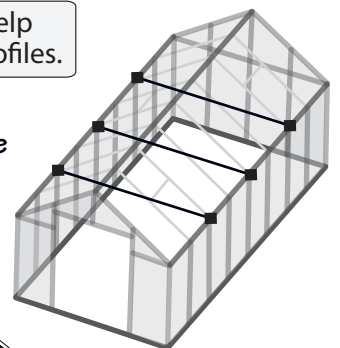

NOTE: VIEWS FROM INSIDE.

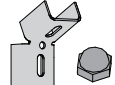

NOTE: VIEW FROM OUTSIDE.

	QTY	Connector	QTY
	3		6
			6

8.3A Working from back right corner, remove plastic film from both sides of one W-1 panel. With side marked "UV Resistant" facing outside, fit top end of panel into channel in R-1 roof ridge near corner. Push panel into roof ridge channel until the other end rests on gutter ledge and then slide towards F-7 corner profile. Repeat to install W-1 panel in back left corner.

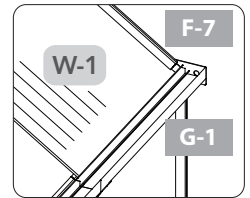
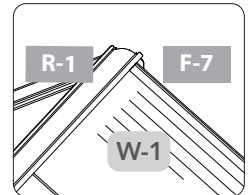
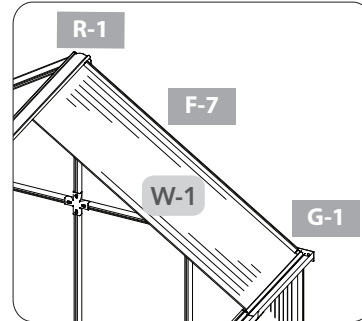
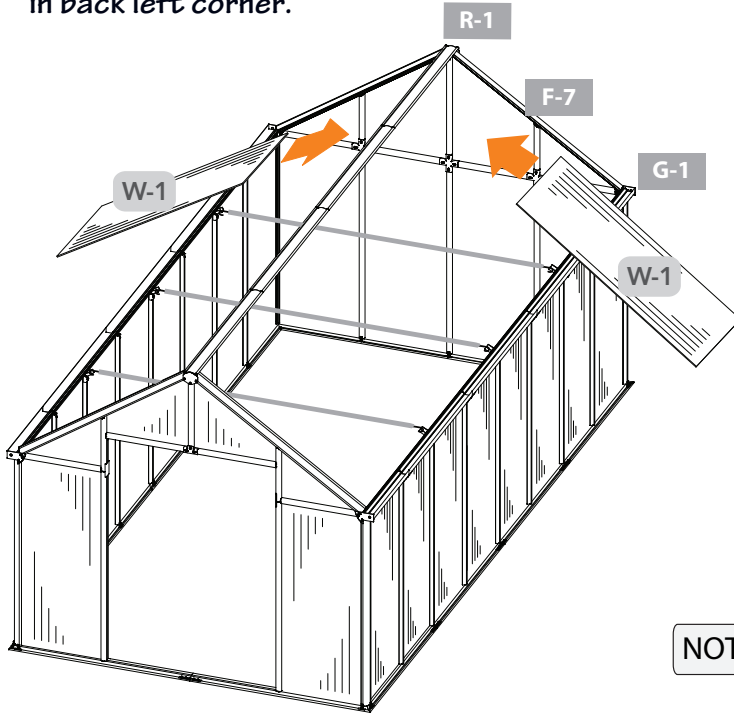
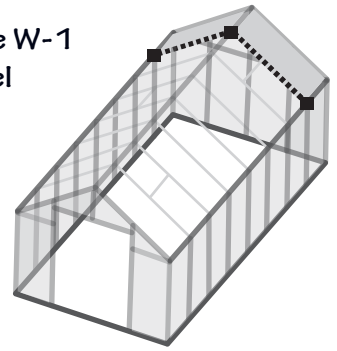

NOTE: VIEWS FROM OUTSIDE.

8.3B With two set screws facing inside, fit one F-1 profile next to right panel. F-1 profile rests against widest part of roof ridge and lines up with top of gutter.

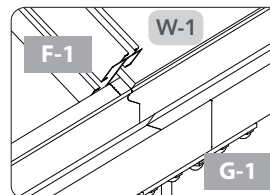
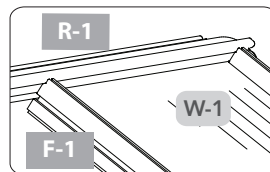
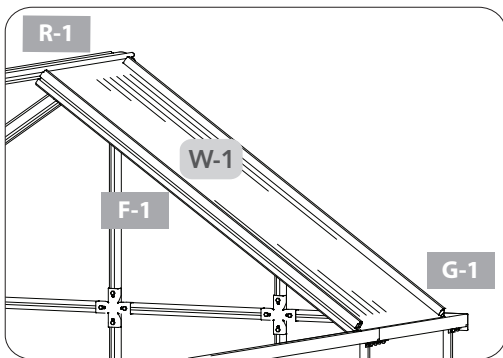

NOTE: VIEWS FROM OUTSIDE.

8.3C From inside, hold profile in place with one B-4 connector. Secure with two bolts.

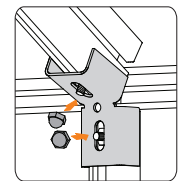
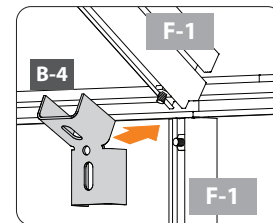



NOTE: VIEWS FROM INSIDE.

8.3D Repeat step 8.2B through 8.2C to secure install and secure F-1 profile on left side.

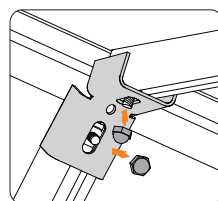
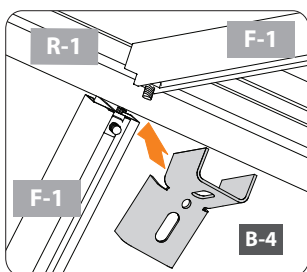
8.3E Hold two profiles together at ridge using one B-4 connector. Secure with two bolts.



NOTE: VIEWS FROM INSIDE.

Panel	QTY	Connector	QTY
 24" x 57"	2		3
			6

8.4A Continue working from front right corner. Remove plastic film from both sides of one W-1 panel. With side marked "UV Resistant" facing outside, fit top end of panel into channel in roof ridge near corner. Push panel into roof ridge channel until the other end rests on gutter ledge and then slide towards F-7 corner profile. Repeat to install W-1 panel in front left corner.

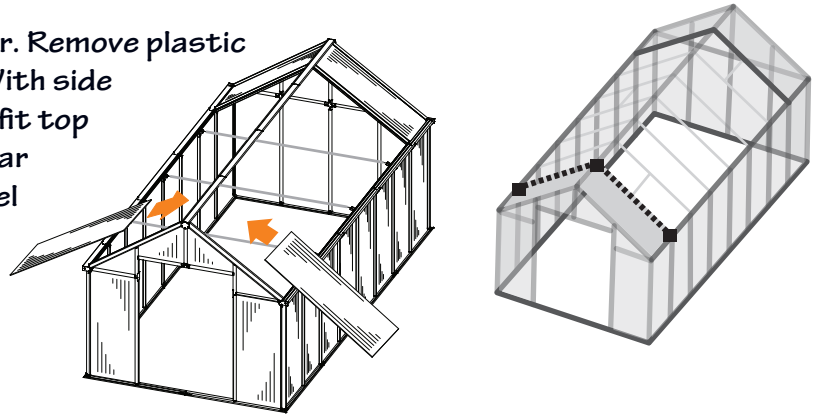

NOTE: VIEWS FROM OUTSIDE.

8.4B From inside, fit one F-1 profile with two set screws facing inside next to panel. Hold in place with one B-4 connector on right side. Secure with two bolts. Repeat to install F-1 profile on opposite side.

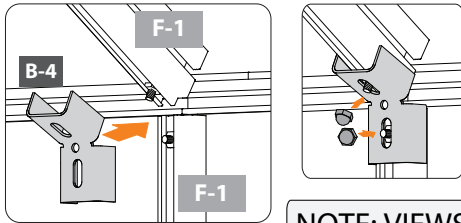

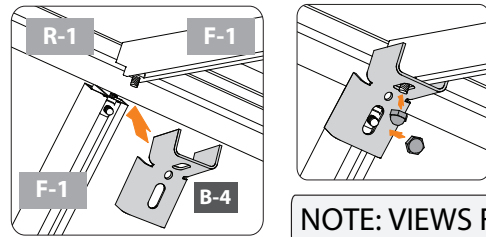

NOTE: VIEWS FROM INSIDE.

8.4C Hold two profiles together at ridge using one B-4 connector. Secure with two bolts.

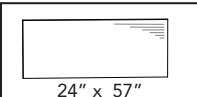

NOTE: VIEWS FROM INSIDE.

Panel	QTY	Connector	QTY
 24" x 57"	W-1	2	 B-4
			 S-2C
			3
			6

8.5A Return to back right to install section three and remove bungee cord nearest to back. Remove plastic film from both sides of one W-1 panel. With side marked "UV Resistant" facing outside, install the next panel on the left at the back. Push panel into roof ridge channel until the other end rests on gutter ledge and then slide towards F-1 profile at back.

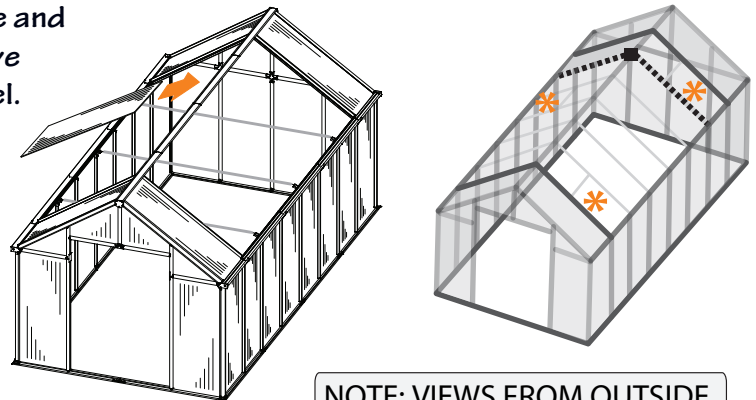

NOTE: VIEWS FROM OUTSIDE.

*NOTE: W-2 panels are installed in step 8.7

8.5B From inside, fit one F-1 profile with three set screws next to panel. Position profile so set screws face inside and middle set screw is closer to top. Fit other end into B-4 connector and secure with one bolt. Repeat to install F-1 profile on opposite side.

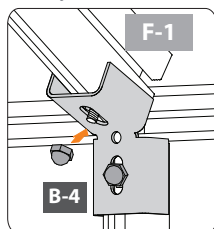



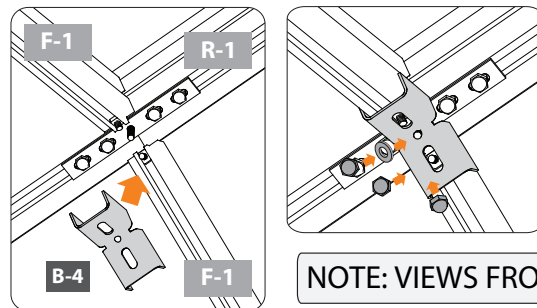

NOTE: VIEWS FROM INSIDE.

8.5C Hold two profiles together in place at ridge using one B-4 connector. Line up center hole with long hex bolt in roof ridge. Place washer on long bolt and secure all screws with three bolts.

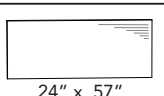

NOTE: VIEWS FROM INSIDE.

Panel	QTY	Connector	QTY	Connector	QTY
 24" x 57"	W-1	1	 S-2C	2	 B-4
					 S-2C
					 S-5B
					1
					3
					1

8.5D Continue working from back to finish section three. Remove plastic film from both sides of one W-1 panel. With side marked "UV Resistant" facing outside, install the next panel on the right at the back. Push panel into roof ridge channel until the other end rests on gutter ledge and then slide towards F-1 profile at back. Repeat to install W-1 panel on left.

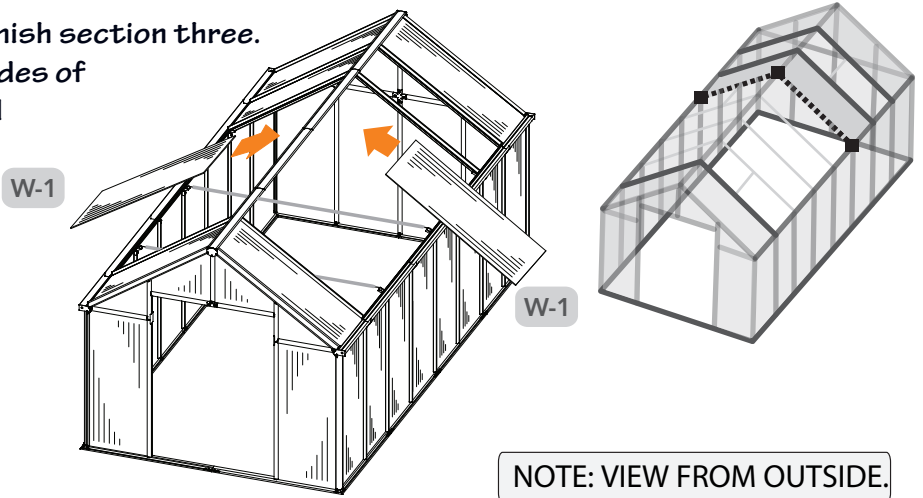

NOTE: VIEW FROM OUTSIDE.

8.5E From inside, fit one F-1 profile with two set screws facing inside next to panel. Hold in place with one B-4 connector on right side. Secure with two bolts. Repeat to install F-1 profile on opposite side.

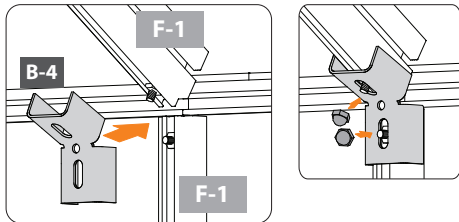

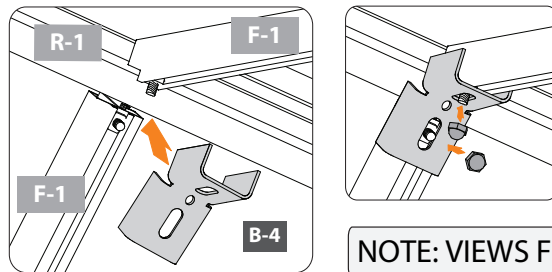

NOTE: VIEWS FROM INSIDE.

8.5F Hold two profiles together at ridge using one B-4 connector. Secure with two bolts.

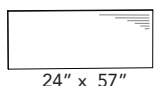

NOTE: VIEWS FROM INSIDE.

Panel	QTY	Connector	QTY
 24" x 57"	W-1		B-4
	2		S-2C
			3
			6

8.6A Remove next bungee cord and continue working from back to install section four. Remove plastic film from both sides of one W-1 panel. With side marked "UV Resistant" facing outside, install the next panel on the right at the back. Push panel into roof ridge channel until the other end rests on gutter ledge and then slide towards F-1 profile at back.

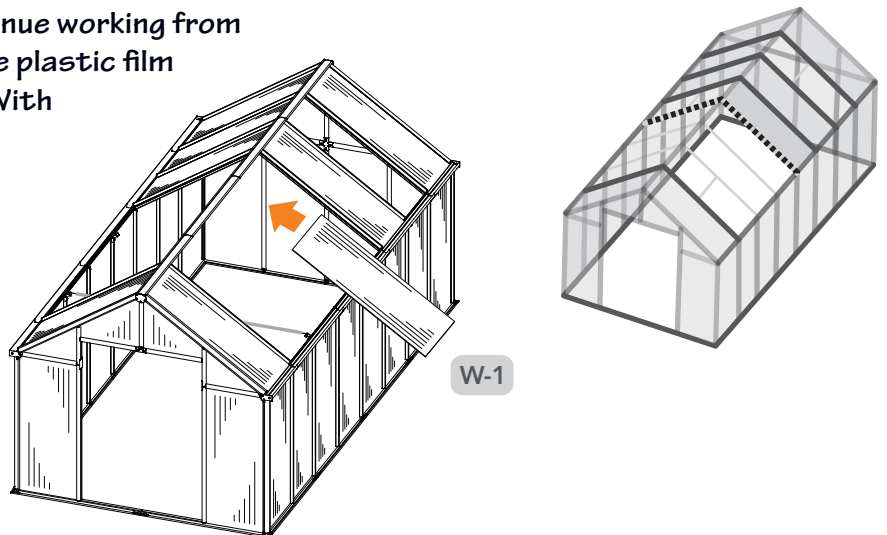

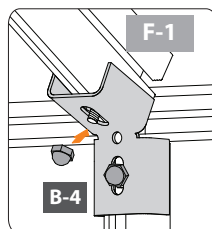

NOTE: VIEW FROM OUTSIDE.

8.6B From inside, fit one F-1 profile with three set screws next to panel. Position profile so set screws face inside and middle set screw is closer to top. Fit other end into B-4 connector and secure with one bolt. Repeat to install F-1 profile on opposite side.

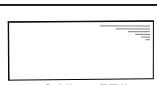

NOTE: VIEW FROM INSIDE.

Panel	QTY	Connector	QTY
 24" x 57"	W-1		S-2C
	1		2

8.6C Hold two profiles together in place at ridge using one B-4 connector. Line up center hole with long hex bolt in roof ridge. Place washer on long bolt and secure all screws with three bolts.

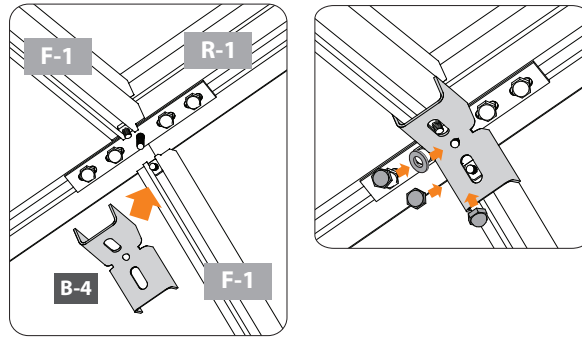

NOTE: VIEWS FROM INSIDE.

8.6D Remove plastic film from both sides of one W-1 panel. With side marked "UV Resistant" facing outside, install the next panel on the right at the back. Push panel into roof ridge channel until the other end rests on gutter ledge and then slide towards F-1 profile at back. Repeat to install W-1 panel on left.

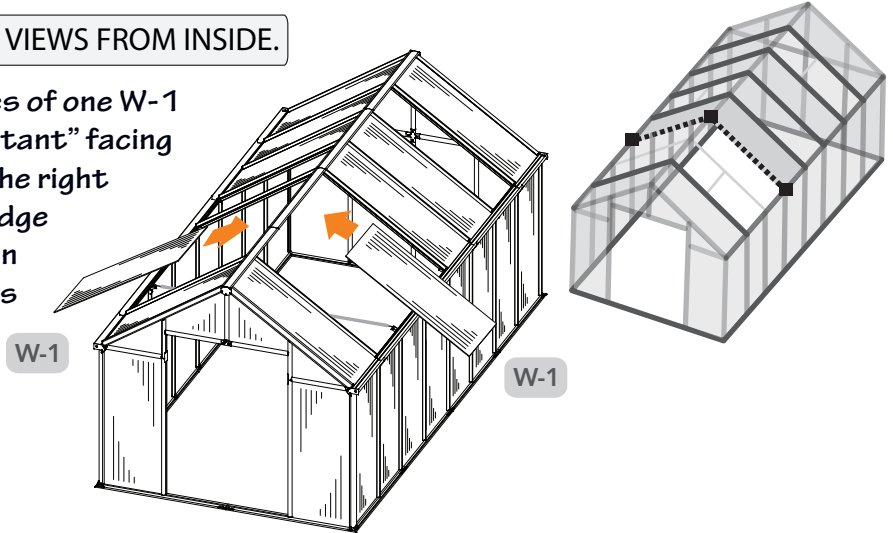

NOTE: VIEW FROM OUTSIDE.

8.6E From inside, fit one F-1 profile with two set screws facing inside next to panel. Hold in place with one B-4 connector on right side. Secure with two bolts. Repeat to install F-1 profile on opposite side.

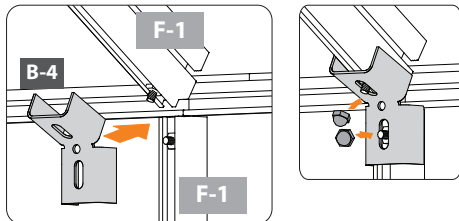

NOTE: VIEWS FROM INSIDE.

8.6F Hold two profiles together at ridge using one B-4 connector. Secure with two bolts.

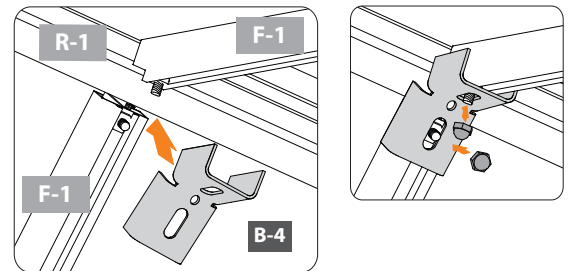





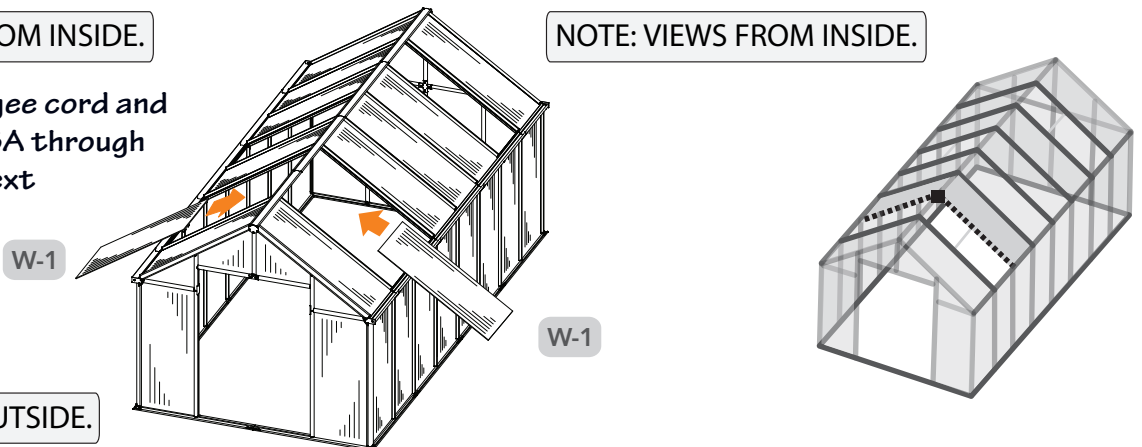

NOTE: VIEWS FROM INSIDE.

8.6G Remove final bungee cord and repeat steps 8.6A through 8.6C to install next two panels.



NOTE: VIEW FROM OUTSIDE.

Panel	QTY	Connector	QTY	Connector	QTY	Connector	QTY
 24" x 57"	W-1	4	 S-2C	2	 B-4	3	 S-2C
			 S-2C	6	 B-4	6	 S-5B
							2

8.7A Continue working from back to install section five. Remove plastic film from both sides of one W-1 panel. With side marked "UV Resistant" facing outside, install next panel at slight angle on left. If necessary, loosen the previous B-4 connector and profile and move them towards the back of the greenhouse to make more room to fit panel in place.

W-1

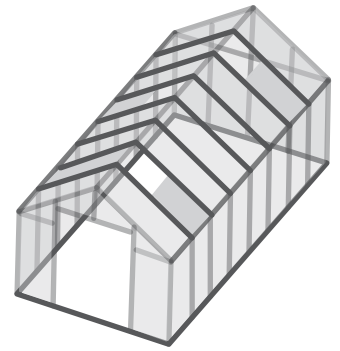
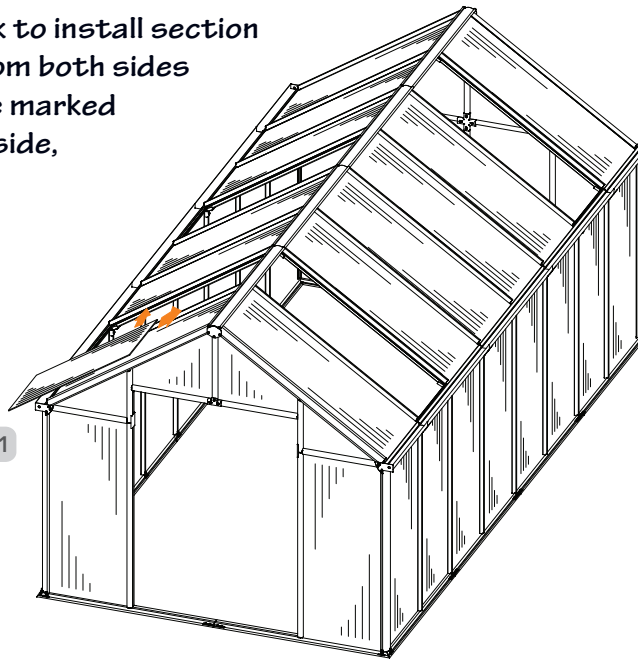

NOTE: VIEW FROM OUTSIDE.

8.7B Remove plastic film from both sides of one W-2 panel. It will be installed opposite the W-1 panel installed in 8.7A. From outside position panel with extended ledge profile at outside top. Install panel at slight angle sliding all the way into profile. Fit other end into opposite profile. If necessary apply slight pressure to bend panel and snap into place.

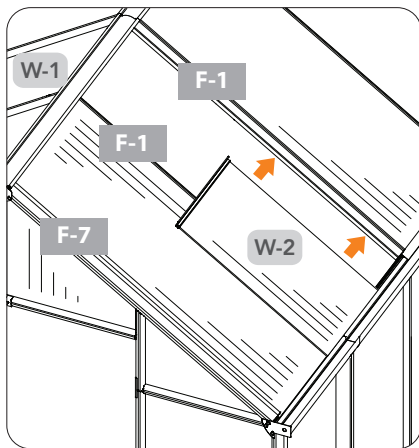

NOTE: VIEW FROM OUTSIDE.

8.7C Remove plastic film from both sides of second W-2 panel and repeat step 8.7B to install in second section from back right.

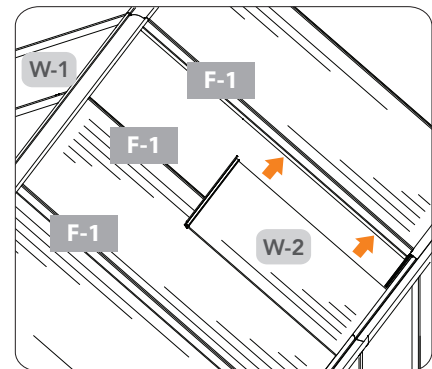

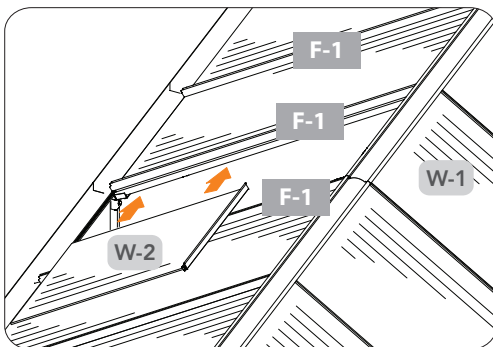

NOTE: VIEW FROM OUTSIDE.

8.7D Remove plastic film from both sides of second W-2 panel and repeat step 8.7B to install in fourth section from back left.





NOTE: VIEW FROM OUTSIDE.

Panel	QTY	Panel	QTY
 24" x 57"	W-1 1	 24" x 32 1/4"	W-2 3

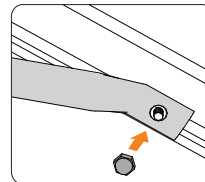
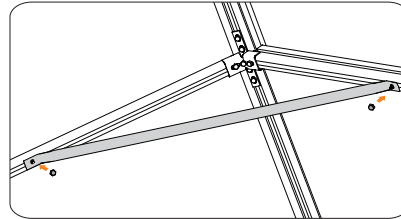
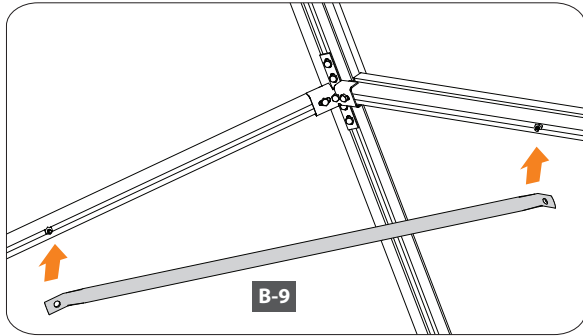
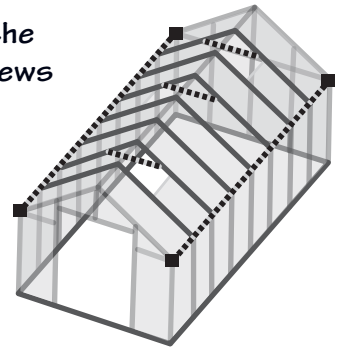
8.8 Have one person stand outside the greenhouse to observe the position of the roof ridge while the other person installs the three B-9 braces. The set screws should be in the correct position, but if the roof is not completely straight, loosen the set screws and adjust the brace to raise or lower the roof line. Secure each with two bolts.

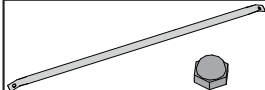

NOTE: VIEWS FROM INSIDE.

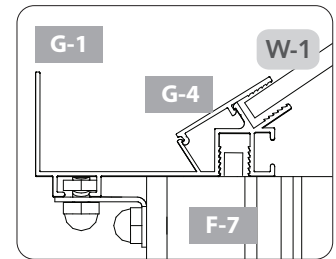
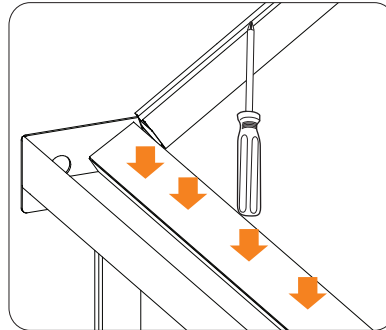
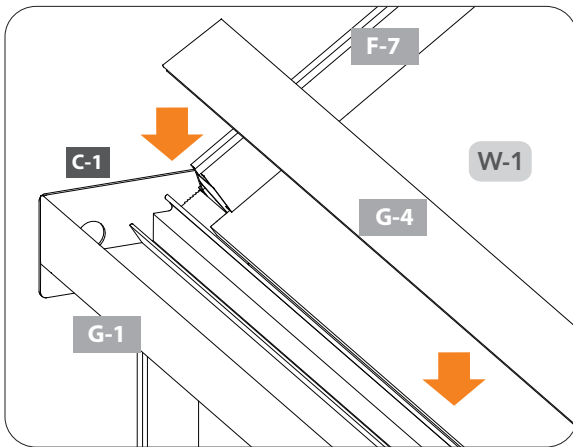

Brace		QTY
	B-9	3
	S-2C	6

8.9 The G-4 and G-4E trim plates snap into G-1 and G-2 gutter profiles to hold roof panels in place. Working from outside, begin at front corner. Position G-4 trim plate over gutter and use handle of screw driver to tap into place. Use two G-4 and two G-4E trim plates on each side. Make sure the seams of the trim plates are flush with each other and to the C-1 connectors at the front. NOTE: There may be a slight gap at the rear C-1 connector depending on weather conditions.

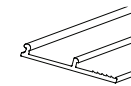

NOTE: View shows alignment of G-4 and G-1 only.

NOTE: VIEWS FROM OUTSIDE.

Trim Plate		QTY
	49 3/8"	G-4 4
	48 1/2"	G-4E 4

8.10 Screw G-3 gutter drain into holes in C-1 connectors. Make sure they point down.

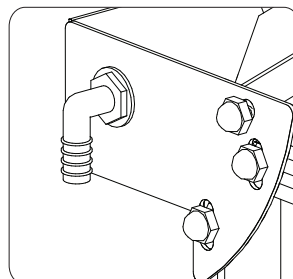
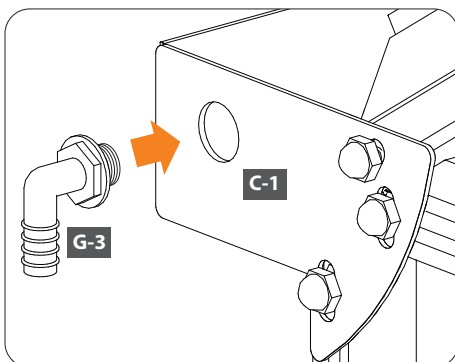

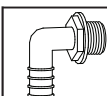
Gutter Drain		QTY
	G-3	4

Install Roof Vents



Make certain the pieces are in the correct positions before assembling. Carefully follow the order of assembly to ensure an easy installation. Wear proper safety gear including work shoes, gloves and goggles.

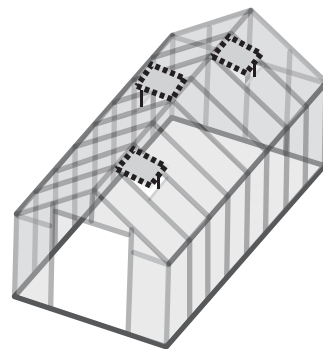

9.1A Unpack contents of Automatic Window Opener. Screw adjusting knob partially into threaded end of cylinder. Do NOT tighten.

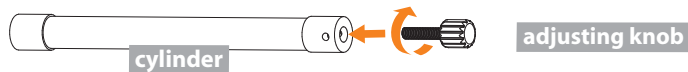

9.1B Fit piston rod connected to arm B into end of cylinder. Turn cylinder so holes next to adjusting knob are visible.

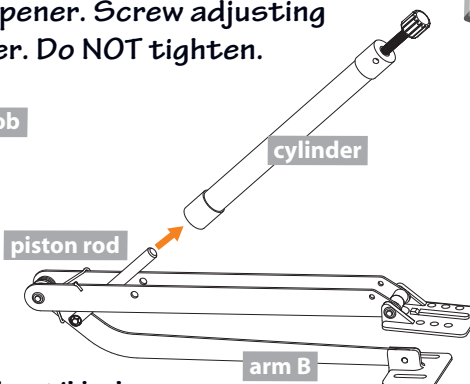

9.1C Continue pushing cylinder onto piston rod until holes in end of cylinder line up with holes in arm A. Push arms apart if necessary. Secure with a threaded stud on each side.

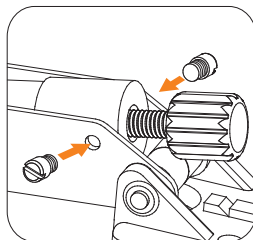
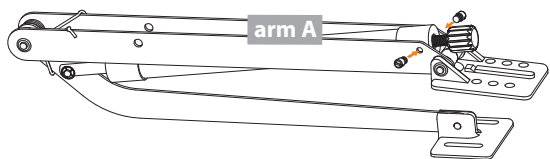

9.1D Turn adjusting screw clockwise until arms are approximately 6" apart.

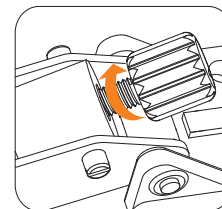

9.1E Repeat steps 9.1A through 9.1D to prepare two more Automatic Window Openers.

NOTE: You will use the Gripping Channels in next steps. You do not need the other included parts in Window Opener package.

Handle	QTY	Cylinder	QTY	Adjusting Knob	QTY	Threaded Stud	QTY
	3		3		3		6

9.2A Remove plastic film from both sides of V-2 factory assembled vents. With side labeled "Face inside" facing up, lay panel on flat clean surface. Measure and mark center of vent.

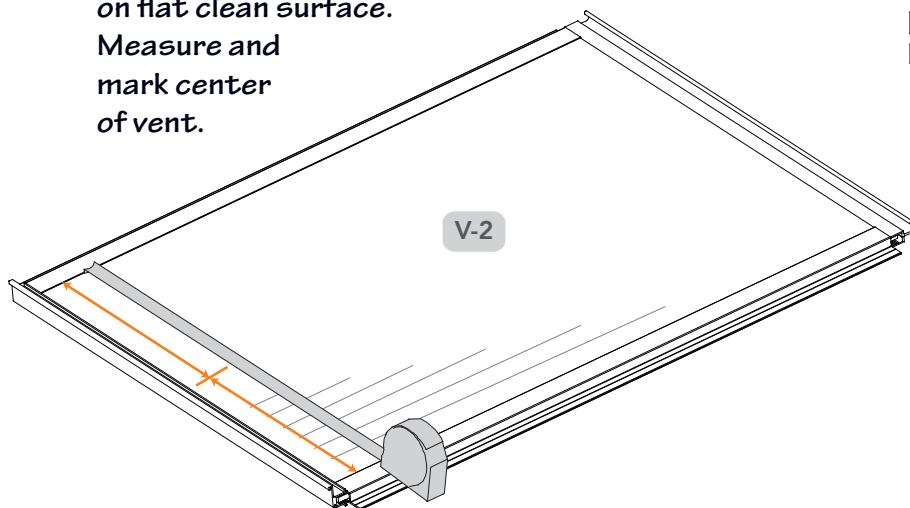

9.2B Place opener with arm A on bottom inside vent. Mark screw placement. Using S-1 screw, apply pressure to puncture the panel and predrill holes for next step.

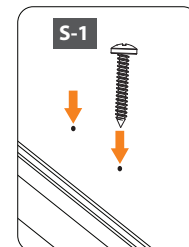
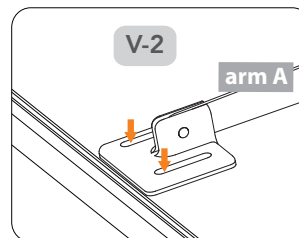

Factory Assembled Vent	QTY
24" x 24 3/4"	3
V-2	3

9.2C Screw two S-1 screws through V-2 panel. Line up gripping channel on other side. Continue to screw until secure. Do not over tighten as it may damage the vent.

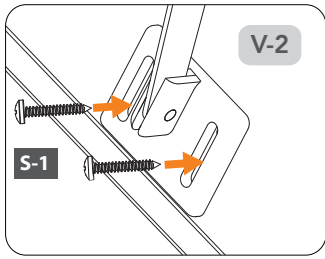

NOTE: VIEW FROM INSIDE.

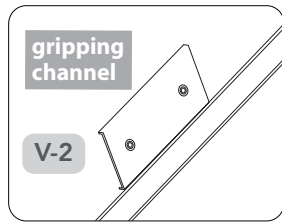

NOTE: VIEW FROM OUTSIDE.

9.2D Repeat steps 9.2A through 9.2C to prepare two more vents.

Connector		QTY	Gripping Channel	QTY
	S-1	6		3

9.3A From inside, hold Window Opener closed against vent. Slide vent at an angle through opening in roof panels. Hook top lip of vent onto curve in ridge profile R-1.

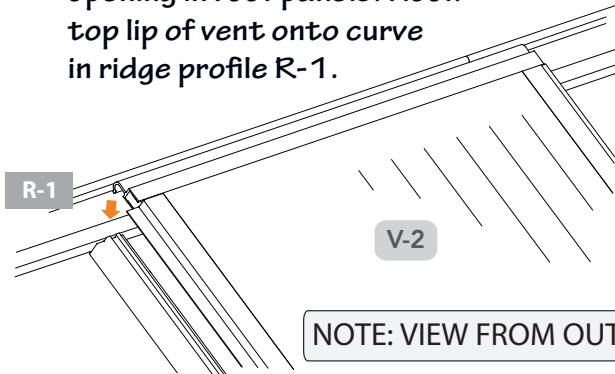

NOTE: VIEW FROM OUTSIDE.

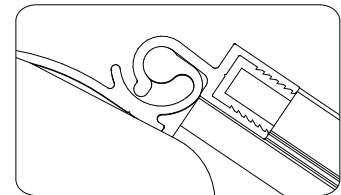
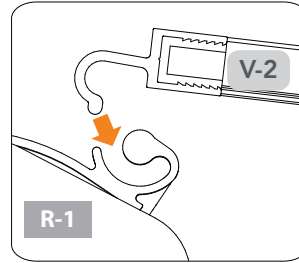

NOTE: VIEWS FROM FRONT.

9.3B Outside of vent rests on top of ledge on W-2 profile. Open vent so you can attach the other arm of opener to top of inside W-2 profile. Screw two S-1 screws through panel and into gripping channel on other side to secure. Do not over tighten as it may damage the vent.

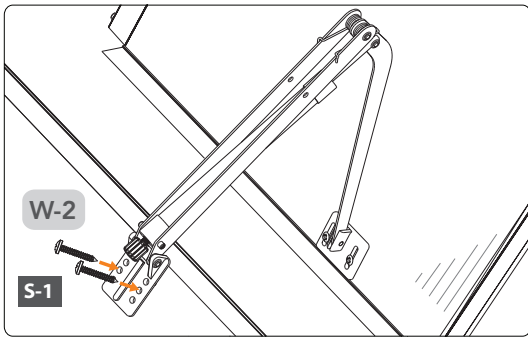

NOTE: VIEW FROM INSIDE.

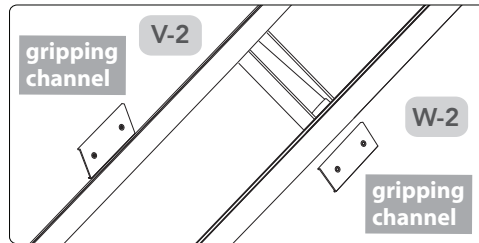

NOTE: VIEW FROM OUTSIDE.

9.3C Repeat steps 9.3A through 9.3B to install two more vents.

Connector		QTY	Gripping Channel	QTY
	S-1	6		3

9.4A From inside screw S-6 screw and spacer into the holes on each end of the top of the vent. This will secure the vent to the greenhouse in very windy conditions.

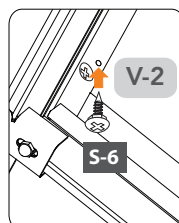
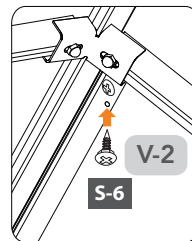
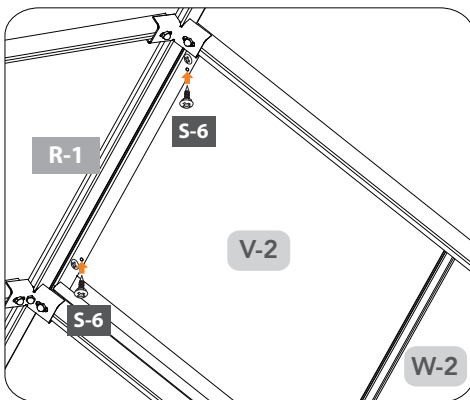

NOTE: VIEWS FROM INSIDE.

9.4B Repeat steps 9.4A to secure two remaining vents.

Connector		QTY
	S-6	6

Install Doors

NOTE: Have the hex shaped indent facing up. Screw in until it is flush with bottom of nut so it slides easily into bolt tracks. After inserting into bolt track, screw in until it holds in place.



Make certain the pieces are in the correct positions before assembling. Carefully follow the order of assembly to ensure an easy installation. Wear proper safety gear including work shoes, gloves and goggles. Prepare needed set screws as shown in step 1.1A

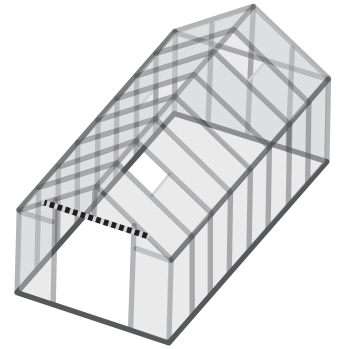

10.1A From outside, prepare to install right and left door tracks. The door tracks are secured with the set screws in F-7 profiles on each side and the two set screws in F-5 profile. Remove two bolts from center B-2 connector on F-5 profile. Slide set screws to inside edge of hole.

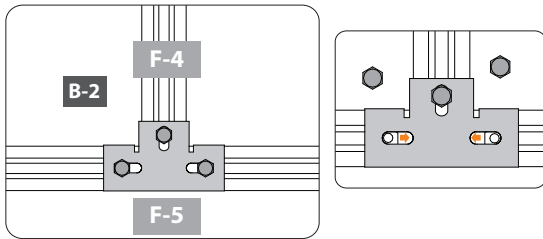

NOTE: VIEW FROM OUTSIDE.

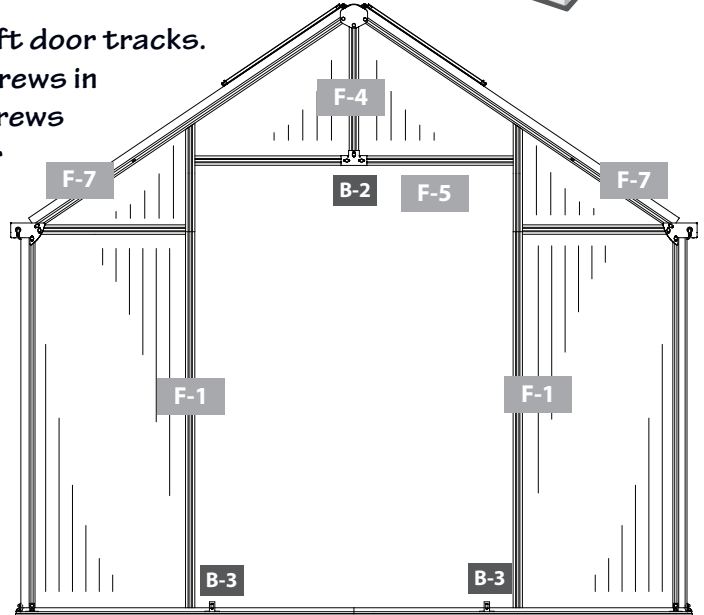

NOTE: ALL VIEWS FROM OUTSIDE.

10.1B Loosen set screw in left F-7 profile and position to line up holes in D-1L as shown. Loosely secure with bolts.

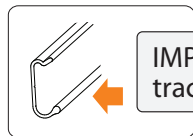
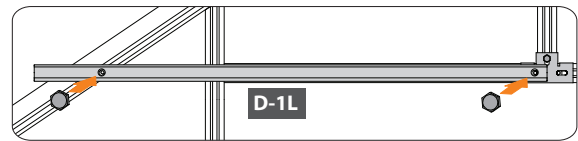
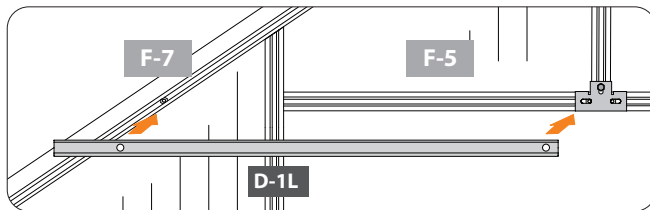

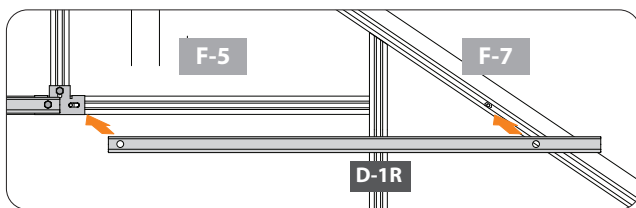

IMPORTANT: Position D-1L and D-1R door tracks with lip on the bottom when installed.

10.1C Loosen set screw in right F-7 profile and position to line up holes in D-1R as shown. Loosely secure with bolts.

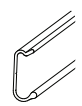

NOTE: ALL VIEWS FROM OUTSIDE.

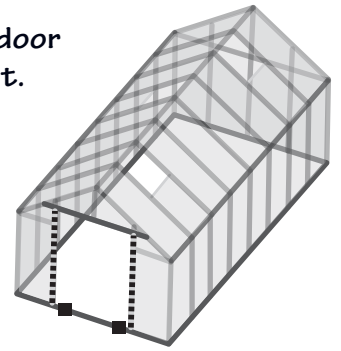
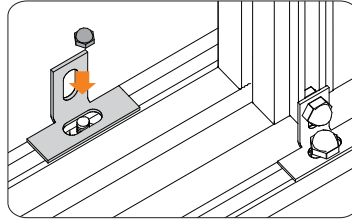
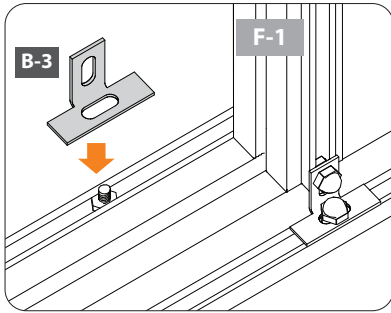

Profile	Length	QTY
	37½"	1
		1

10.2 From the inside, position set screw three inches from right and left F-1 door frame profiles. Install B-3 connector as shown and secure each with a bolt.



NOTE: VIEW FROM INSIDE.

NOTE: These connectors act as door guides and will be wrapped in sealant tape in step 10.3B

Connector	QTY
 B-3	2
 S-2C	2

10.3A Working from the outside, apply the D-4 door sealant tape to the outside of F-1 profiles that make up the door frame. This tape acts as insulation. Beginning directly below D-1L and D-1R door tracks, smooth tape down to P-1A and P-1B base profile, make sure the tape is even. Cut each strip at the bottom.

10.3B Wrap the top part of each of the B-3 door guides with the D-4 door sealant tape.

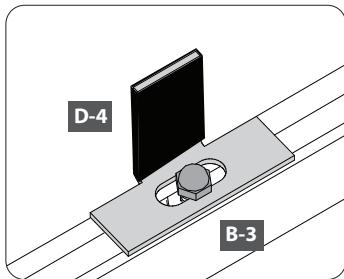

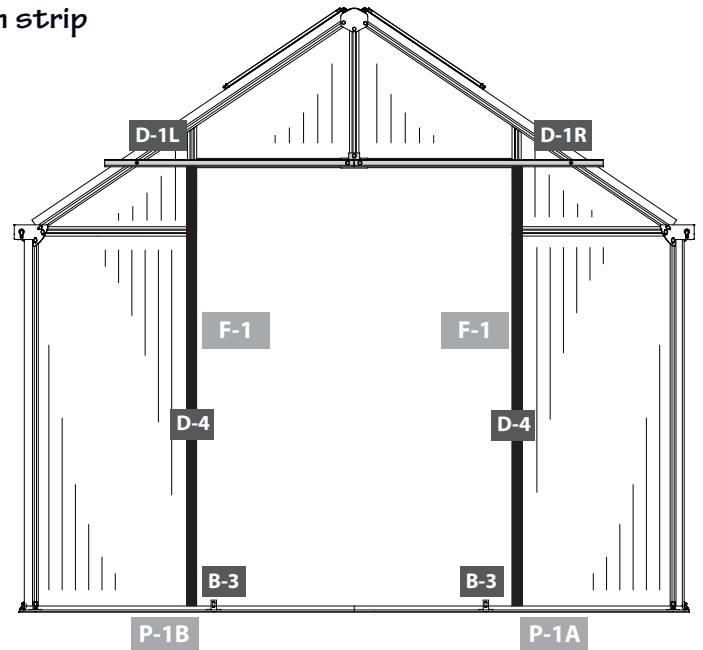

NOTE: VIEW FROM INSIDE.

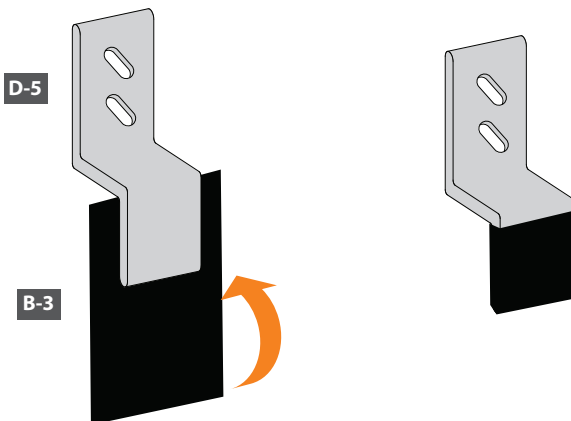

NOTE: VIEW FROM OUTSIDE.

10.3C Wrap the bottom part of each of the D-5 door guides with the D-4 door sealant tape.

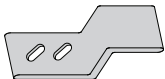

Door Sealant Tape	QTY	Door Guide	QTY
 D-4	12'	 D-5	2

10.4A To install D-2L factory assembled door, remove the bolt attaching left door track D-1L to F-7 profile. With the wheels facing inside, line up so they roll into the left door track. As you roll the door along the track, make certain it slides inside the B-3 door guide installed in step 10.2. Continue to roll door until it stops next to the bolt at the center. Secure using the bolt you removed.

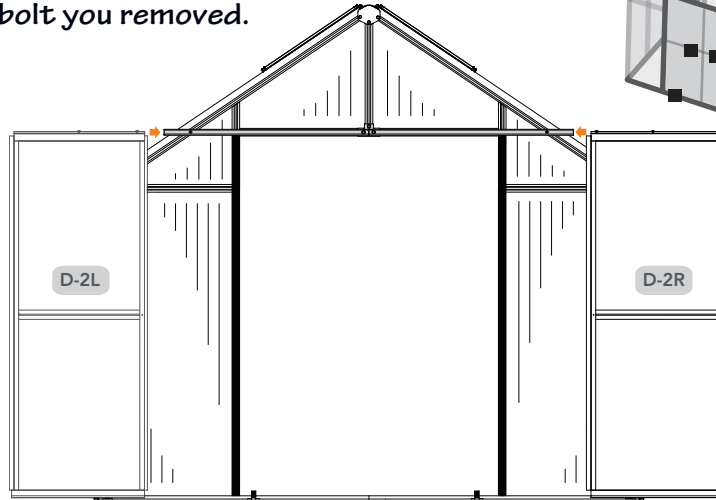
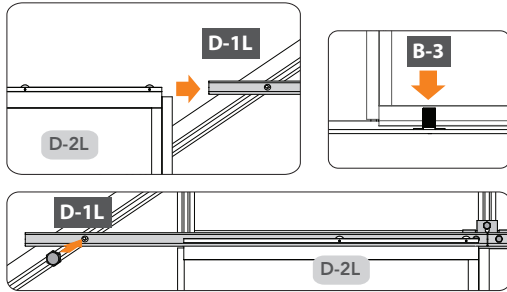
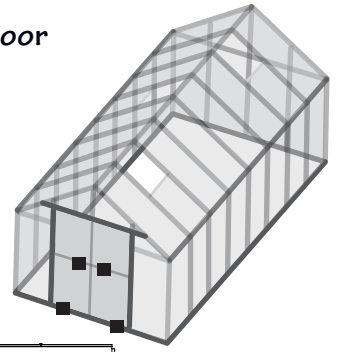

NOTE: VIEWS FROM OUTSIDE.

10.4B Repeat step 10.4A to install the right door.

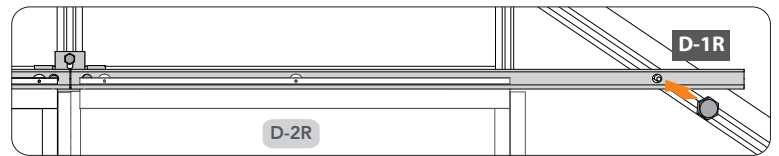
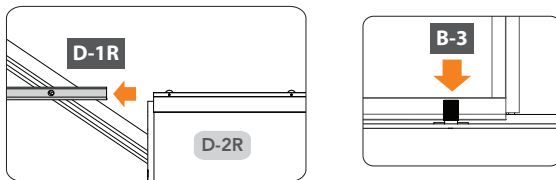

NOTE: VIEWS FROM OUTSIDE.

10.4C Make sure the doors hang properly, slide easily and look straight. If you need to adjust either one or both, loosen the center bolts to either raise or lower each door as needed. Secure the center bolts when finished.

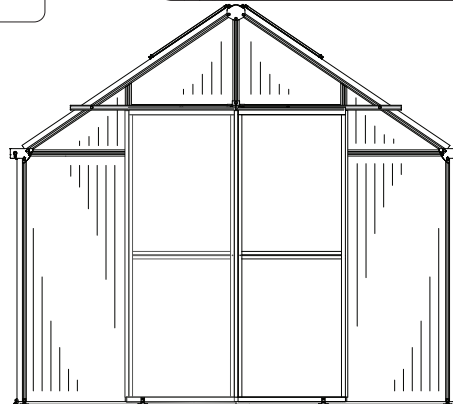

Factory Assembled Doors		QTY
	D-2L	1
	D-2R	1

10.5A Lining up holes in door, install the D-3 door knobs using the included screws.

NOTE: VIEW FROM OUTSIDE.

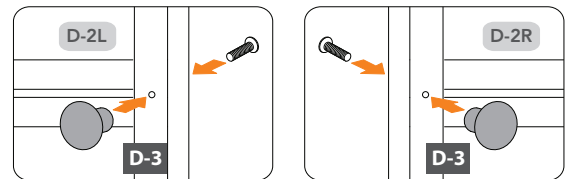

10.5B From the inside, place the D-5 door guide bracket into the channel in the base profile lining holes in bracket with holes in bottom door. Use two S-3 screws to secure. Repeat to install one bracket on each door.

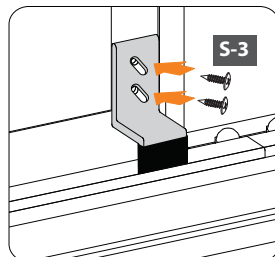
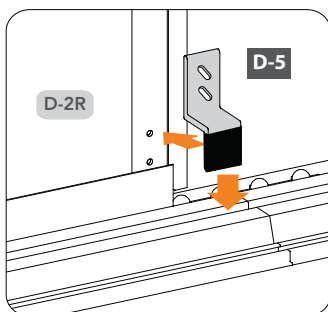

NOTE: VIEW FROM INSIDE.

Door Knob	QTY	Door Guide	QTY		
	D-3	2		S-3	2

Secure to Platform

NOTE: Have the hex shaped indent facing up. Screw in until it is flush with bottom of nut so it slides easily into bolt tracks. After inserting into bolt track, screw in until it holds in place.

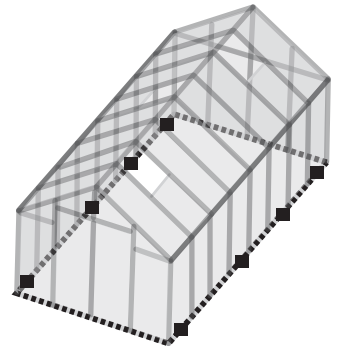

Make certain the pieces are in the correct positions before assembling. Carefully follow the order of assembly to ensure an easy installation. Wear proper safety gear including work shoes, gloves and goggles. Prepare needed set screws as shown in step 1.1A

11.1 The base has predrilled holes in the inside and outside bolt channels so you can easily secure your greenhouse to a wood platform. Screw S-4 screw into hole in base through wood until screw is flush with base profile. Continue process around outside and inside of greenhouse until it is evenly secured.

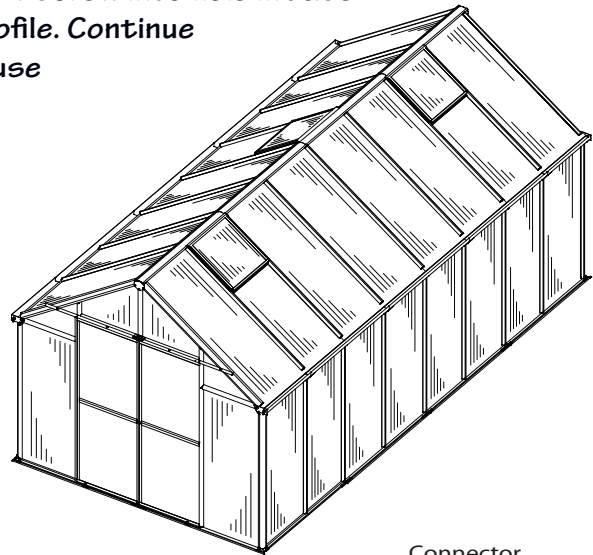
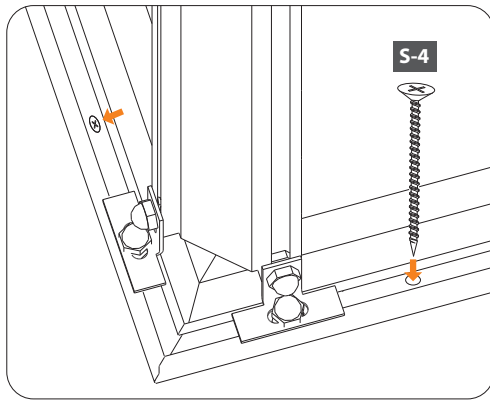

NOTE: The S-4 screw is designed to be used with wood. When securing base to foundations made of materials other than wood, use an appropriate fastener.

Connector		QTY
	S-4	74

11.2 Use eight A-1 ground anchors with eight A-2 anchor brackets on the inside of the greenhouse to secure it to the ground. Place on each side at the front, center and back.

11.2B Screw each A-1 ground anchor through hole in center of bracket. Use a screw driver through the top of A-1 anchor to screw completely into soil. Make certain it is secured in ground.

11.2A Attach each anchor bracket with two set screws in the inside bolt channels in base profile. Secure each with two bolts.

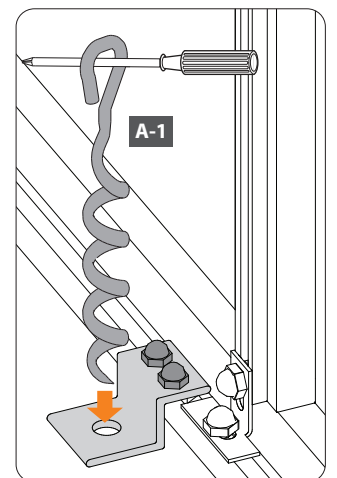
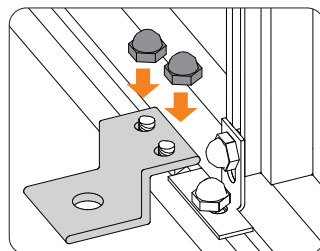
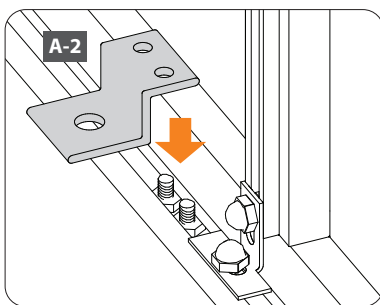

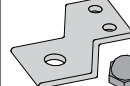
Ground Anchor		QTY	Bracket		QTY
	A-1	8		A-2 S-2C	8 16